

Ilmenau
Art. Nr. 442300
1/15

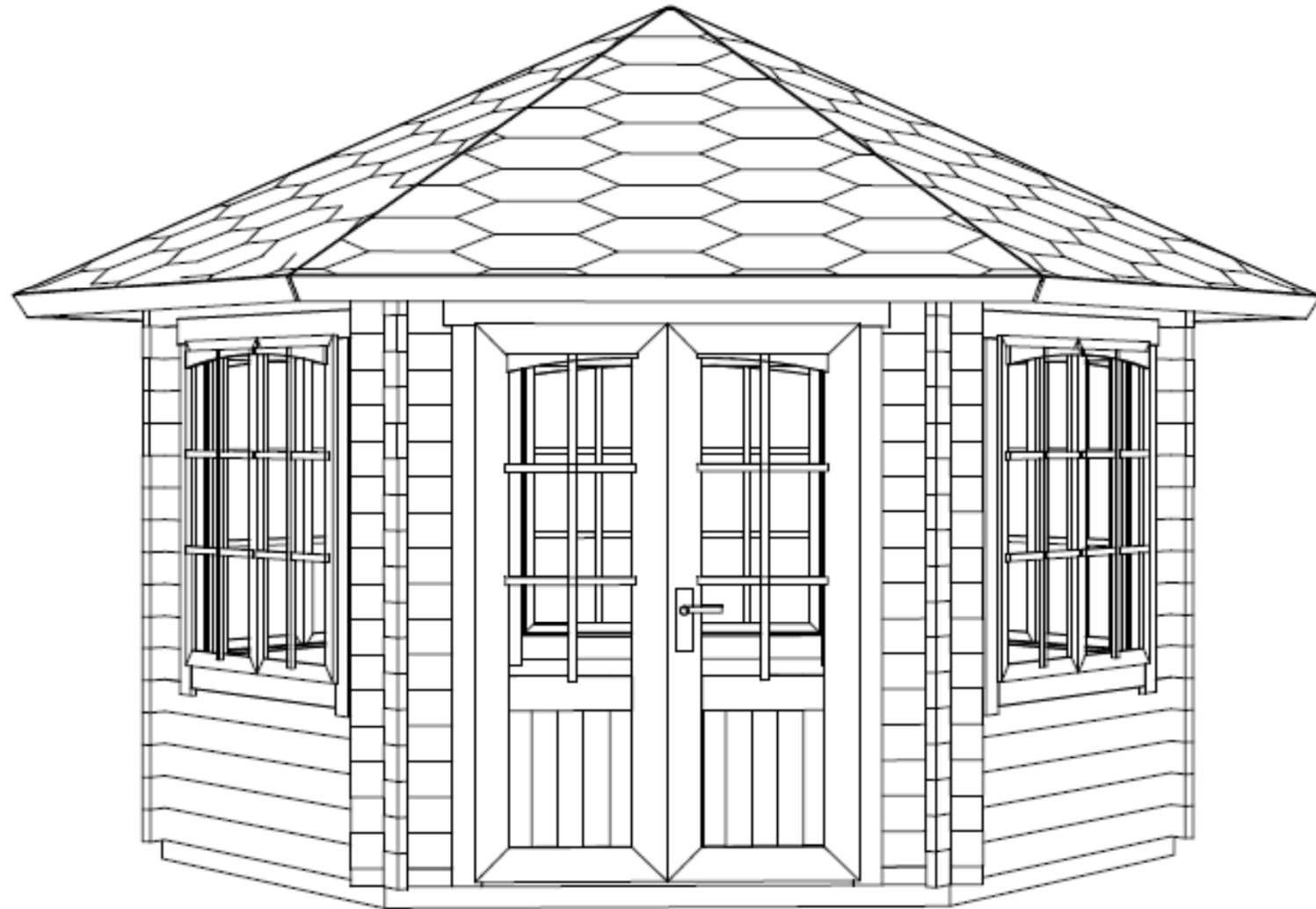

Art.Nr. 442300

GROUNDPLAN - GRUNDPLAN - PLAN DE MASSE

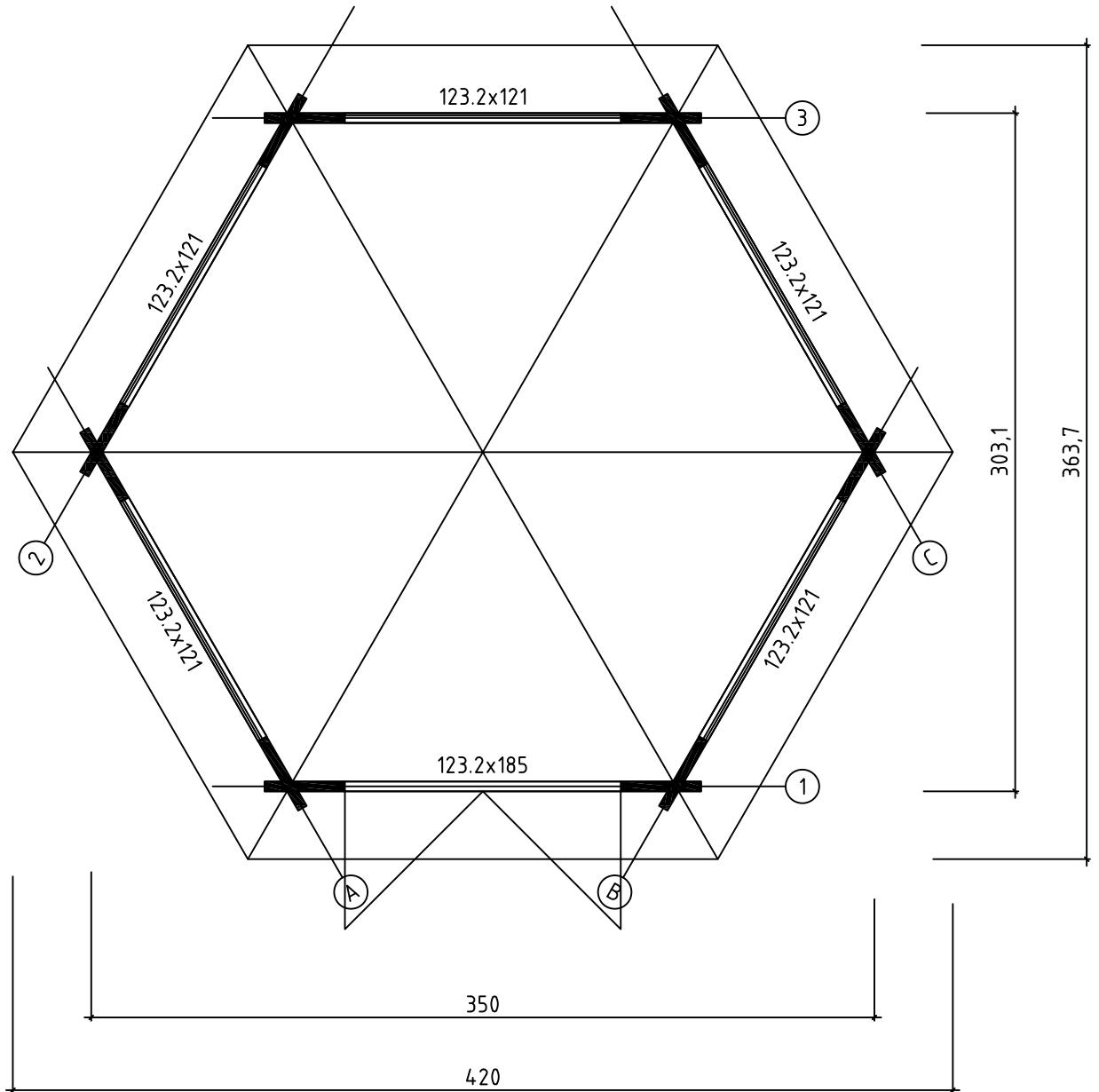

Art.Nr. 442300

FOUNDATION - FUNDAMENT - FONDAZIONE

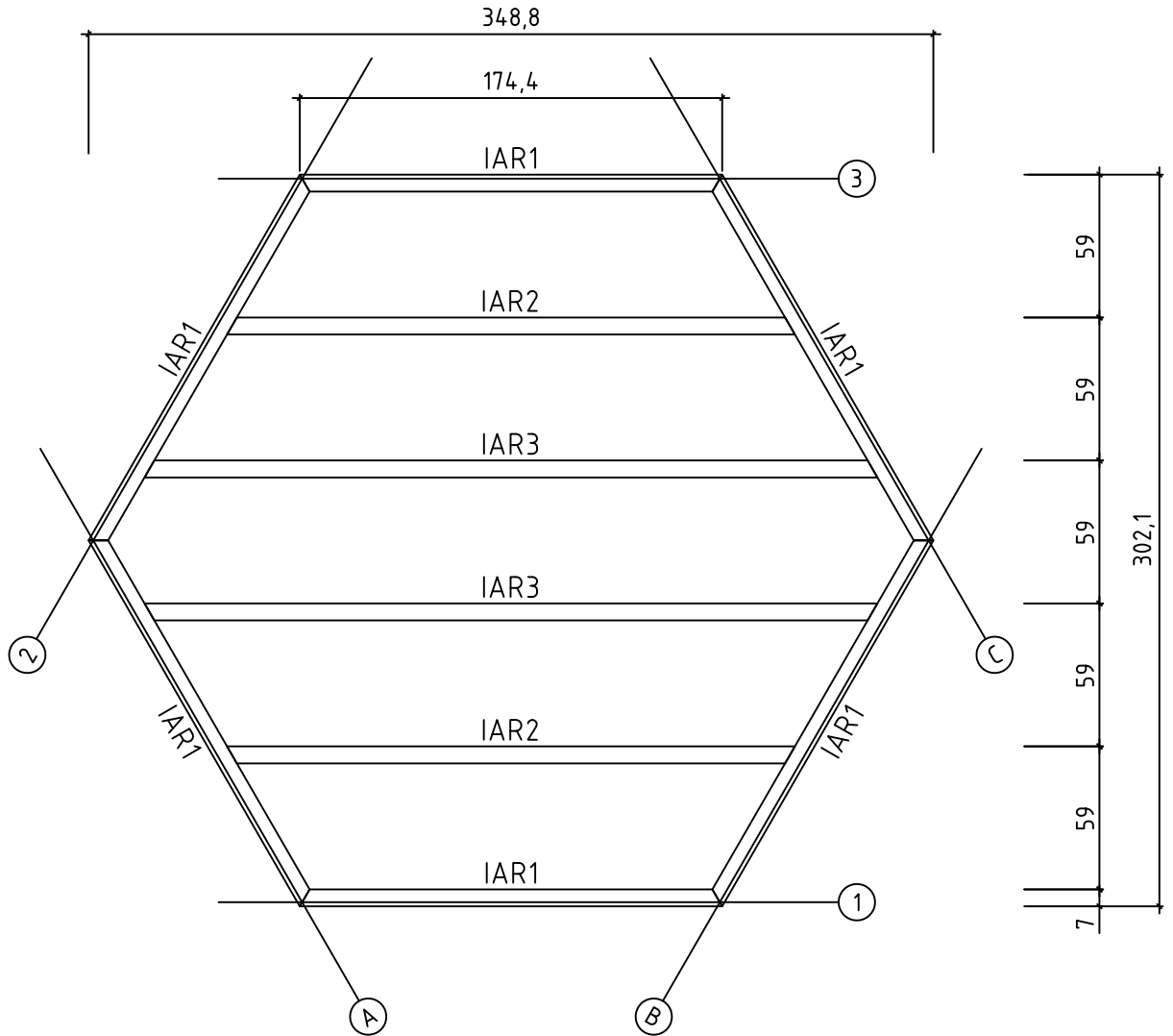

Art.Nr. 442300

FLOOR BOARDS - FUSSBODENBRETTER - PLAN POSE PLANCHER

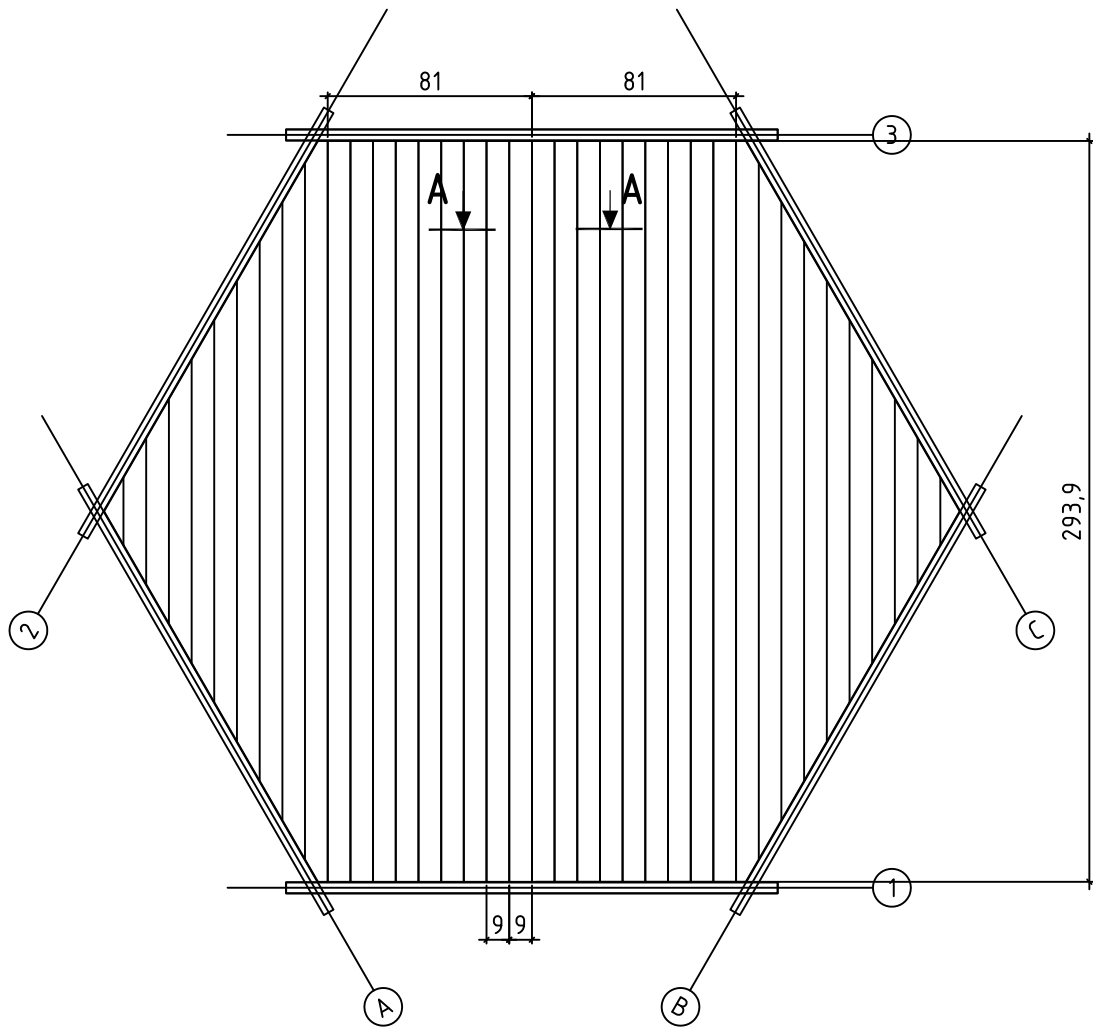

A - A

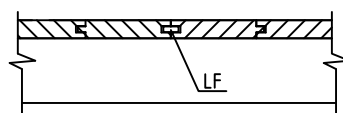

Art.Nr. 442300

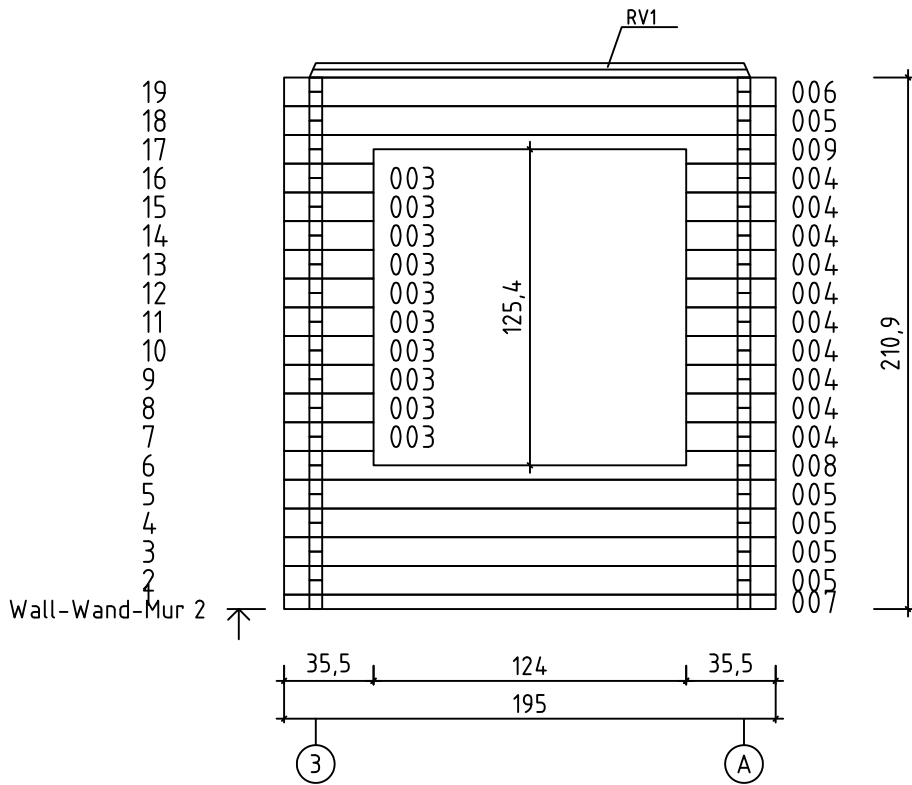
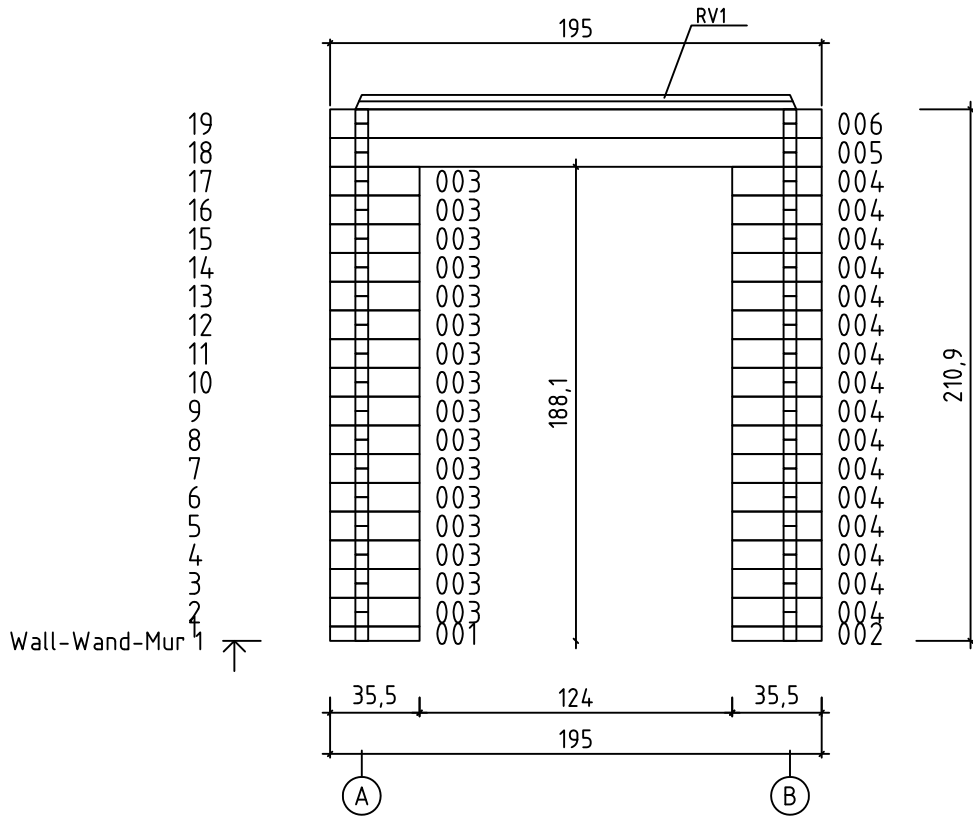

Art.Nr. 442300

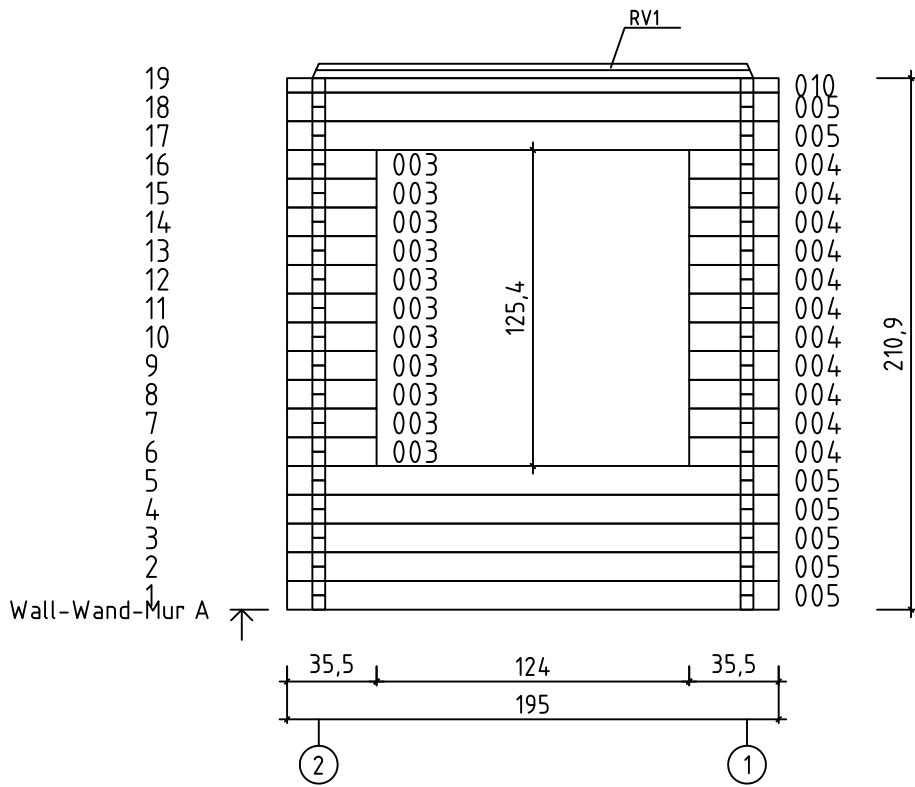
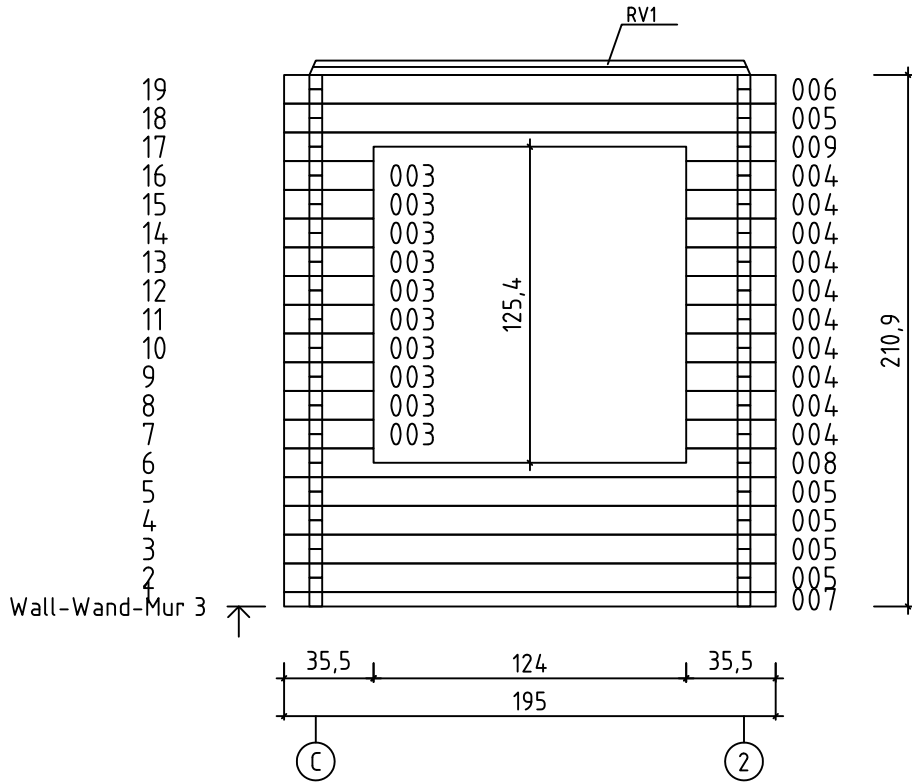

Art.Nr. 442300

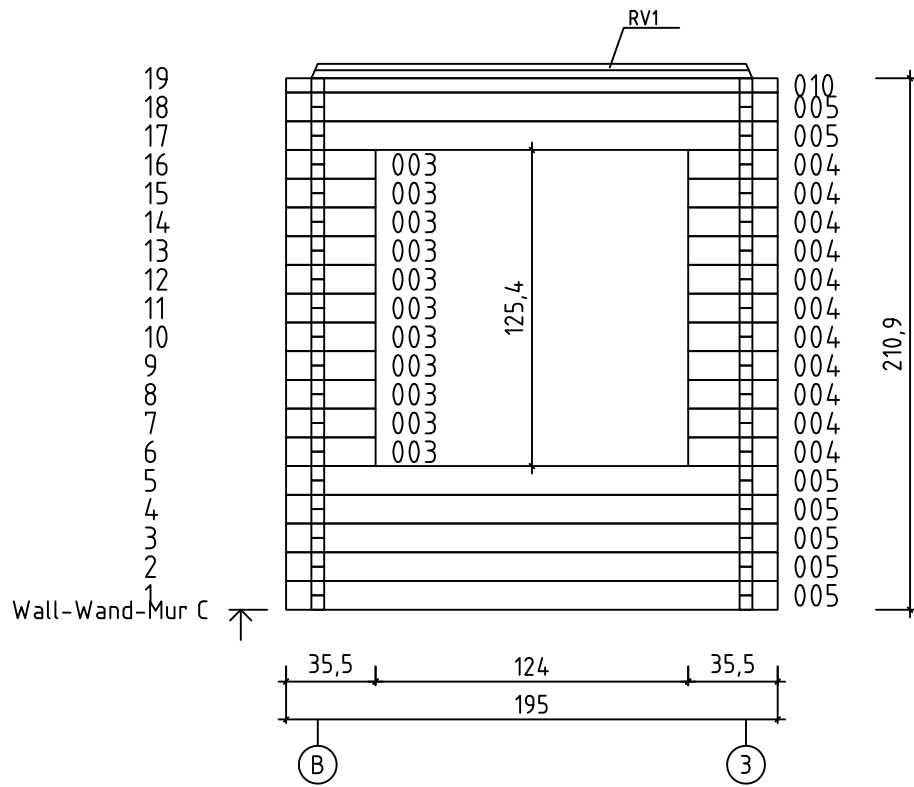
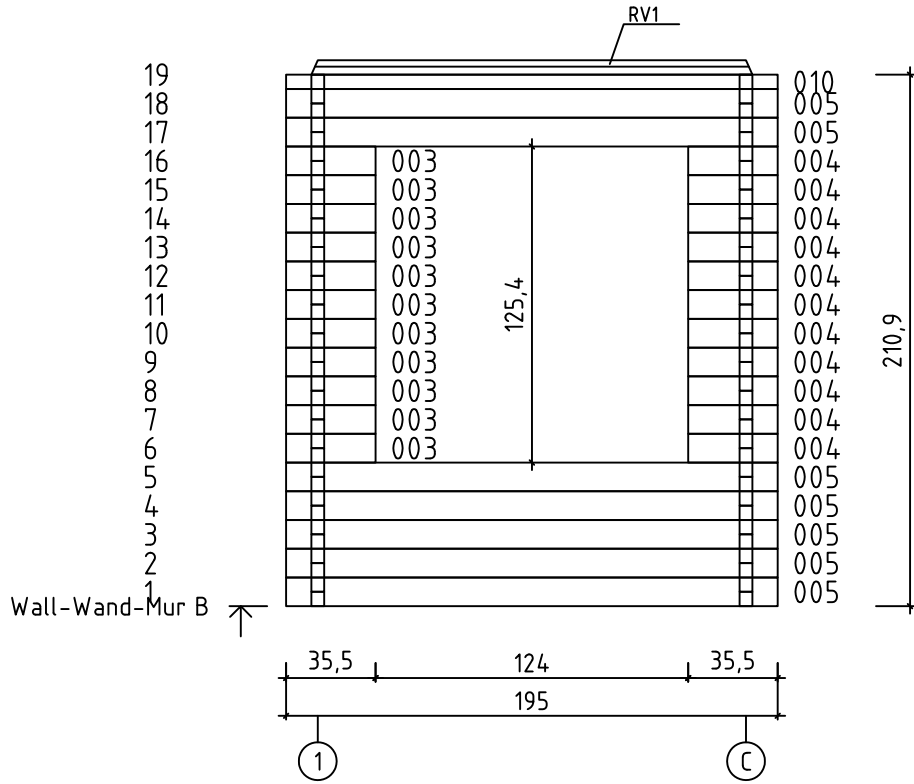

Art.Nr. 442300

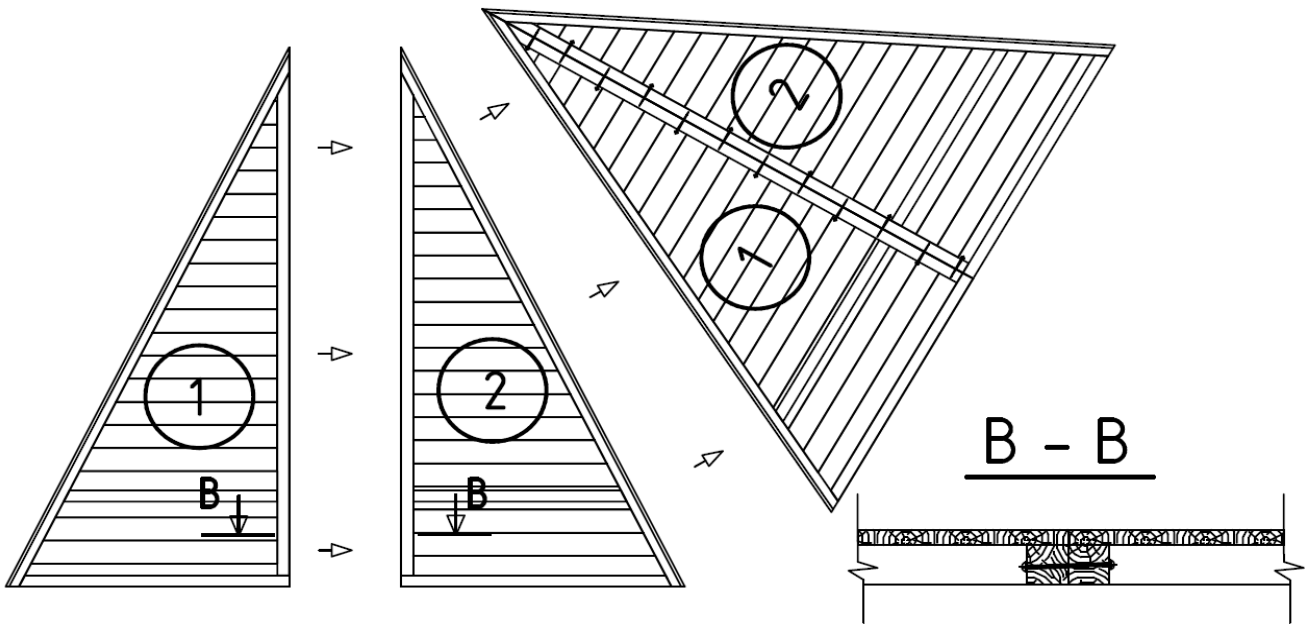

ATTACH LEFT AND RIGHT (1 & 2) ROOF PANELS TOGETHER, USING 2 SCREWS HS1 (12 PCS TOTAL) AT THE LOWEST PART (B-B). THEN AT REGULAR INTERVALS USING THE REMAINING 10 SCREWS, ATTACHING THEM ON ALTERNATING SIDES.

VERBINDEN SIE DIE LINKE UND RECHTE (1 & 2) DACHFLÄCHE MIT DEN SCHRAUBEN HS1 (12 STÜCK INSGESAMT) BEGINNEND AN DER TIEFSTEN STELLE (BB). DANN IN REGELMÄßIGEN ABSTÄNDEN DIE RESTLICHEN SCHRAUBEN VON BEIDEN SEITEN BIS HIN ZUR SPITZE ANBRINGEN.

ASSEMBLER LES PANNEAUX DE TOIT 1 ET 2 AVEC LES VIS (HS1 - 12 VIS AU TOTAL) EN LES RÉPARTISSANT À INTERVALLE RÉGULIER COMME LE MONTRE LE DESSIN CI-DESSOUS.

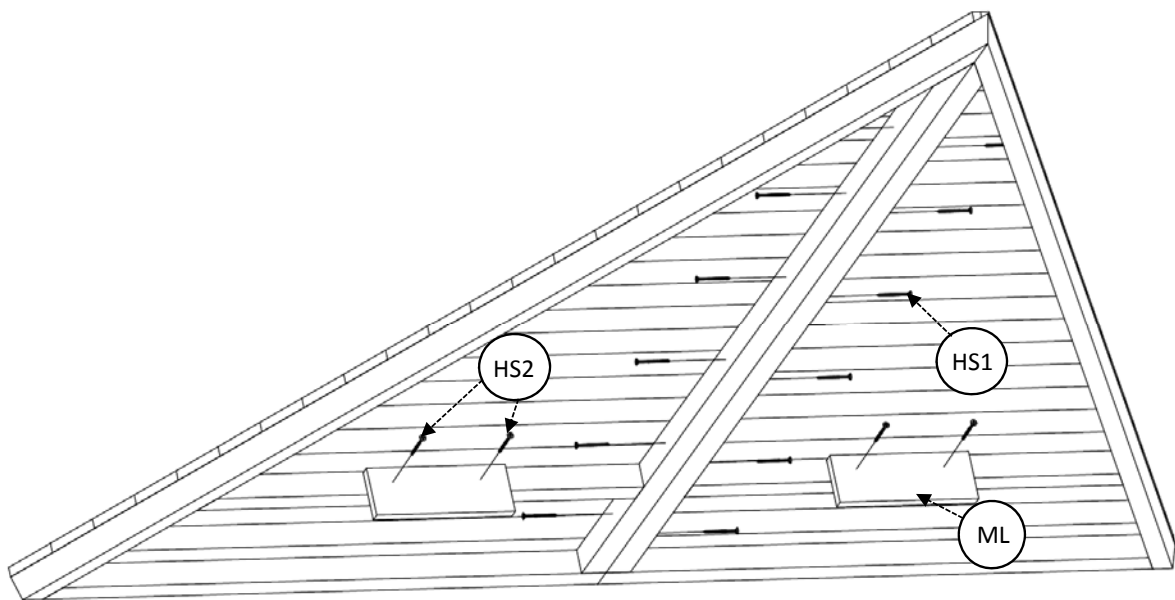

USING 2 SCREWS (HS2) ATTACH ML TO THE LOWER PART CROSS BATTEN ON THE UNDERSIDE OF THE ROOF PANEL (THESE ARE TEMPORARY SUPPORTS).

MIT DEN ZWEI SCHRAUBEN (HS2) BEFESTIGEN SIE DIE KOMPONENTE ML AUF DEM UNTEREN RAHMENTEIL. HIERBEI HANDELT ES SICH UM STÜTZEN ZUR BEFESTIGUNG DER DACHFLÄCHEN.

POUR LA MISE EN PLACE DES PANNEAUX DE TOIT, VEUILLEZ VISSER TEMPORAIREMENT LES DÉTAILS ML AUX TRAVERSES INTERMÉDIAIRES AVEC LES 2 VIS (HS2) POUR CHAQUE DÉTAIL ML. UNE FOIS LA MISE EN PLACE DE LA TOITURE TERMINÉE, VOUS POURREZ LES ENLEVER.

Art.Nr. 442300

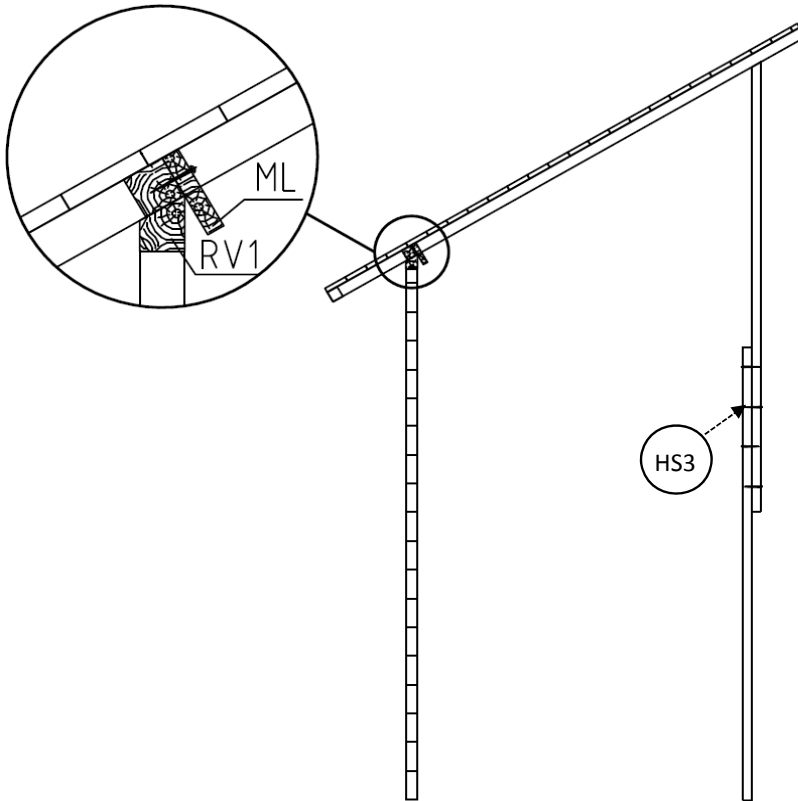

ATTACH TOGETHER PARTS AB SO THAT THE ENTIRE LENGTH IS 2990 MM USING 4 SCREWS PROVIDED HS3. THIS IS A TEMPORARY SUPPORT TO HELP YOU MOUNT THE ROOF.

VERBINDEN SIE DIE BEIDEN KOMPONENTEN A & B MITTELS DER VIER SCHRAUBEN HS3 MITEINANDER. SO DASS DIE LÄNGE 2.990 MM BETRÄGT. HIERBEI HANDELT ES SICH UM EINE TEMPORÄRE STÜTZE ZUR INSTALLATION DER DACHFLÄCHEN.

POUR LA MISE EN PLACE DES PANNEAUX DE TOIT, VEUILLEZ VISSER AVEC 4 VIS (HS3) LES SUPPORTS DE MAINTIEN DE TOIT AB ENSEMBLE DE TELLE SORTE À OBTENIR UN POTEAU D'UNE HAUTEUR TOTALE DE 2 990 MM. UNE FOIS LA MISE EN PLACE DE LA TOITURE TERMINÉE, VOUS POURREZ L'ENLEVER.

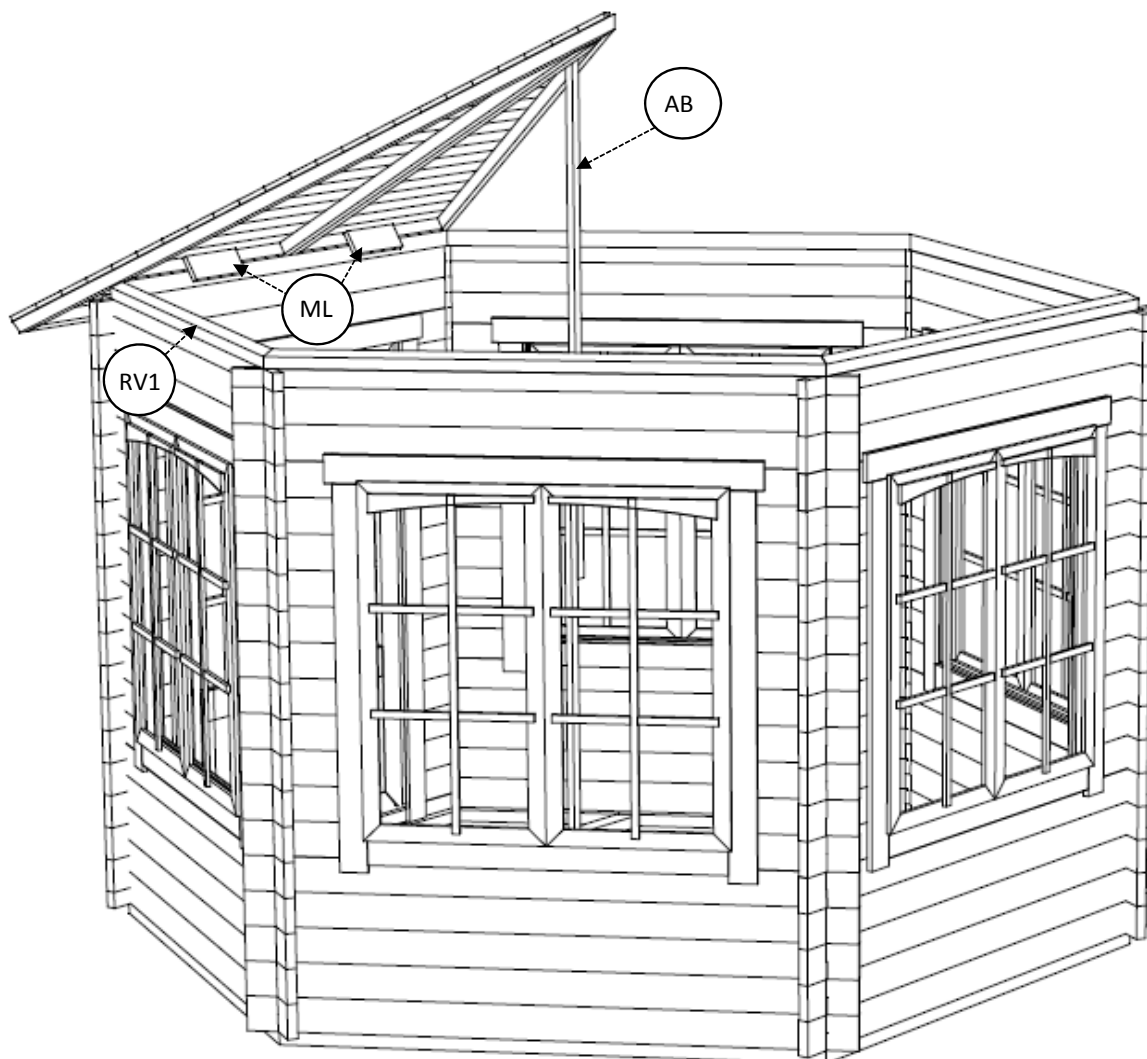

Art.Nr. 442300

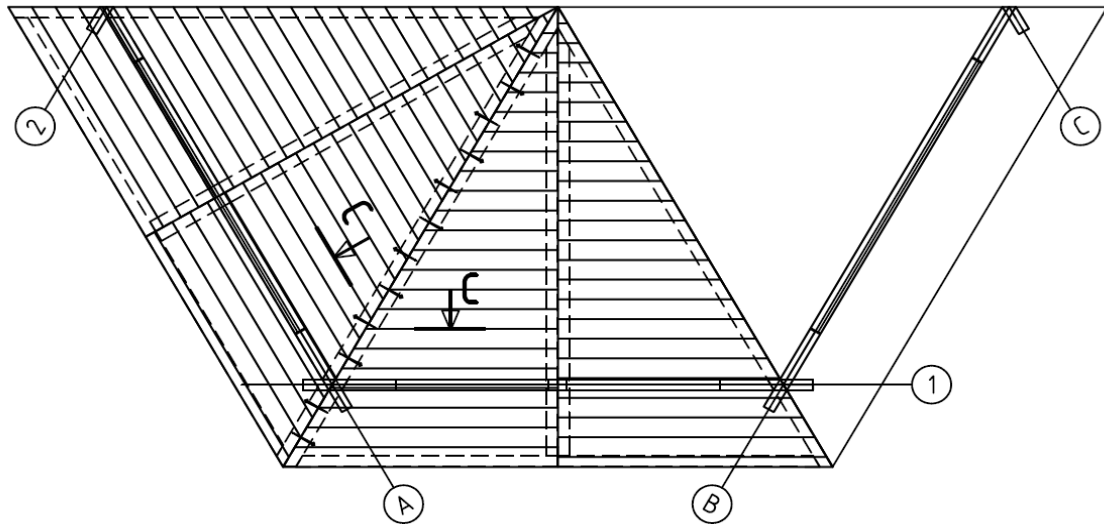

MOUNT THE FIRST ROOF SECTION YOU HAVE CREATED NEXT TO THE SECOND ONE (C-C), (WITH THE HELP OF ROOF SUPPORT AB) - MAKING SURE THEY ARE ALIGNED AND USING SCREWS HS1 (12 PCS) SCREW ALTERNATE SIDES ALL THE WAY UP, (DO NOT TIGHTEN UNTIL ALL PANELS HAVE BEEN ATTACHED, YOU MAY NEED TO ADJUST THE POSITIONING AND HEIGHT AT THE END). ONCE THE CORRECT POSITIONING HAS BEEN ACHIEVED TIGHTEN ALL SCREWS.

MONTIEREN SIE NUN NACHEINANDER DIE EINZELNEN DACHFLÄCHENDREIECKE UNTER ZUHILFENAHME DER STÜTZE AB. VERBIDNEN SIE DIE EINZELNEN DREIECKE WIEDER MIT DEN SCHRAUBEN HS1 (12 ST.) VOM BODEN BIS ZUR SPITZE. DIE SCHRAUBEN BITTE NICHT SOFORT FEST ANZIEHEN, SO DASS SIE DIE DACHELEMENTE GGF. NOCH JUSTIERT WERDEN KÖNNEN. NACHDEM ALLE DREIECKE AN SEINER KORREKTEN POSITION SIND UND DAS DACH JUSTIERT WURDE, BITTE DIE SCHRAUBEN FEST ANZIEHEN.

PLACER SUR LE TOIT LES ÉLÉMENTS DE TOIT PRÉASSEMBLÉS CÔTE À CÔTE (C - C) , EN VOUS AIDANT DU POTEAU DE MAINTIEN DE TOIT AB. ASSUREZ-VOUS DE LEUR BON ALIGNEMENT ET VISSER LES ENSEMBLE À INTERVALLE RÉGULIER EN UTILISANT LES VIS HS1 (12 VIS POUR FIXER À CHAQUE FOIS 2 PANNEAUX). ATTENTION, NE PAS VISSER À FOND TANT QUE TOUS LES PANNEAUX NE SONT PAS MIS EN PLACE, CAR VOUS AUREZ PEUT-ÊTRE BESOIN D'AJUSTER LE POSITIONNEMENT DE CERTAINS D'ENTRE EUX. UNE FOIS TOUS LES PANNEAUX DE TOIT MIS EN PLACE CORRECTEMENT, ALORS VISSER À FOND.

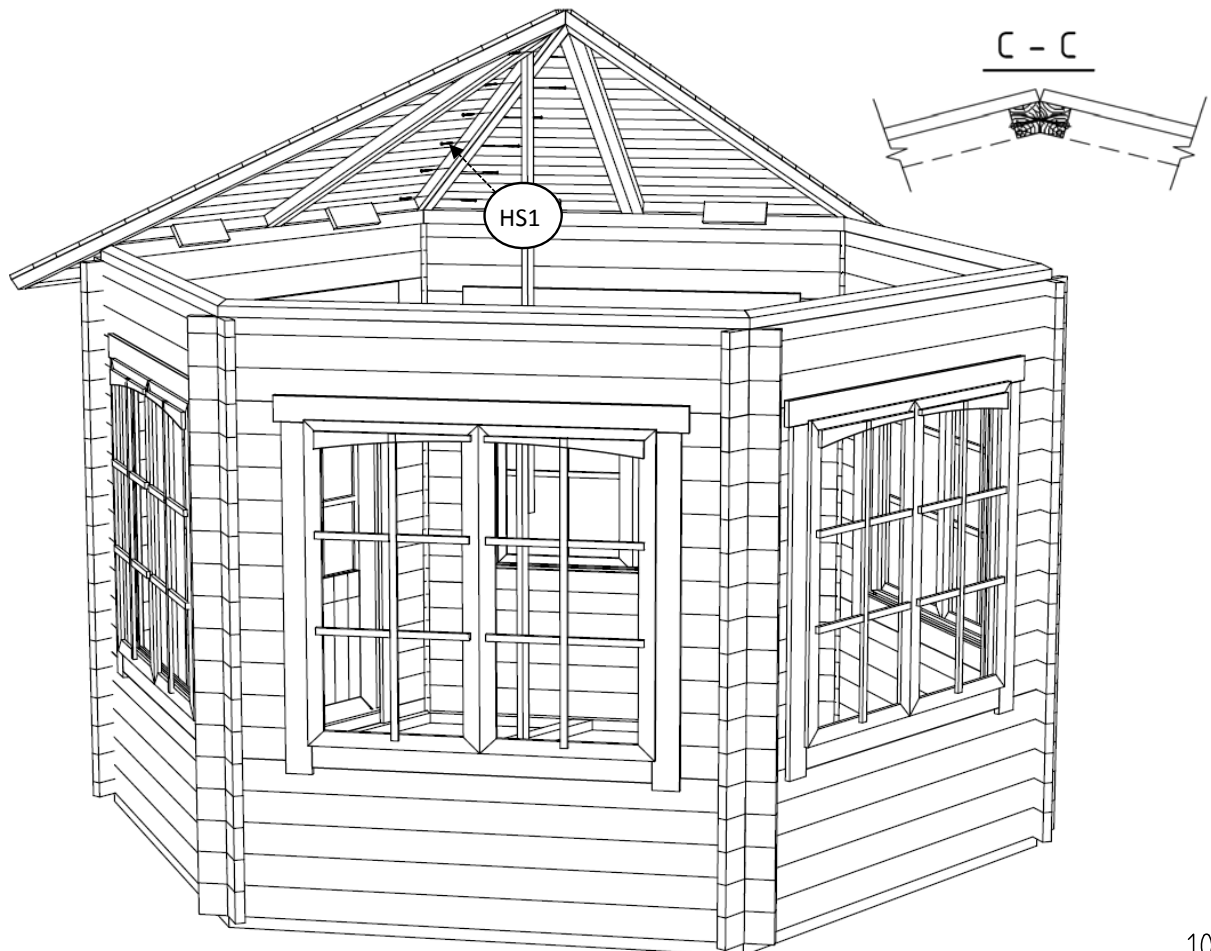

Art.Nr. 442300

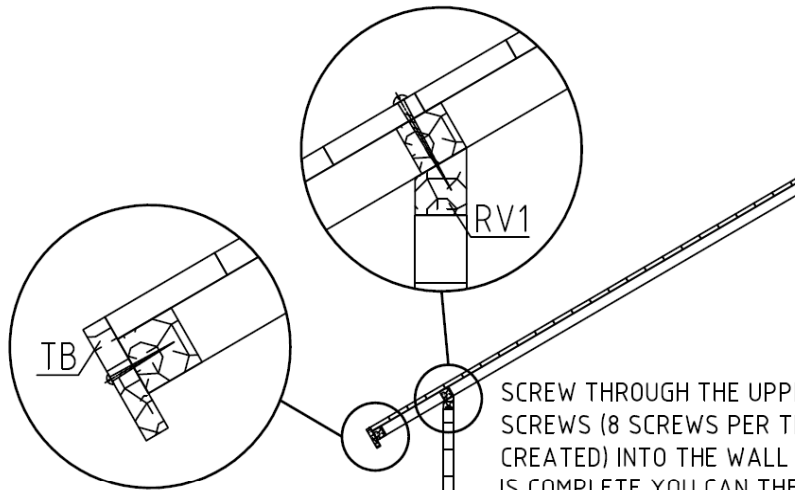

UNDER THE EAVES OF THE ROOF EDGE ATTACH THE FASCIA BOARD TB USING SCREWS PROVIDED HS5 (3 PCS).

ANSCHLIEßEND BRINGEN SIE BITTE DIE UMLAUFENDEN ABSCHLUßBRETTER (TB) MITTELS DER DREI SCHRAUBEN HS5 JEWEILS AM UNTEREN RAHMENTEIL DER DACHFLÄCHENDREIECKE AN.

FIXER LES PLANCHES DE RIVES TB AUX EXTRÉMITÉS VISIBLES DES PANNEAUX DE TOIT AVEC LES VIS HS5 (3 VIS PAR PLANCHE).

SCREW THROUGH THE UPPER PART OF THE ROOFING USING HS4 SCREWS (8 SCREWS PER THE DOUBLE PANEL SECTION YOU CREATED) INTO THE WALL SECTION UNDERNEATH (RV1). ONCE THIS IS COMPLETE YOU CAN THEN REMOVE THE TEMPORARY SUPPORTS ML AND HS3.

SCHRAUBEN SIE NUN DURCH DIE DACHELEMENTE (B/B, C/C ETC.) DIE SCHRAUBEN HS4 (8 SCHRAUBEN JE DOPPELDREIECK) IN DIE DARUNTER LIEGENDE KOMPONENTE RV1 UM DIE DACHFLÄCHEN MIT DEN WÄNDEN ZU VERBINDEN. SOBALD DIES ABGESCHLOSSEN IST, KÖNNEN DIE TEMPORÄREN STÜTZEN ML UND A/B ENTFERNT WERDEN.



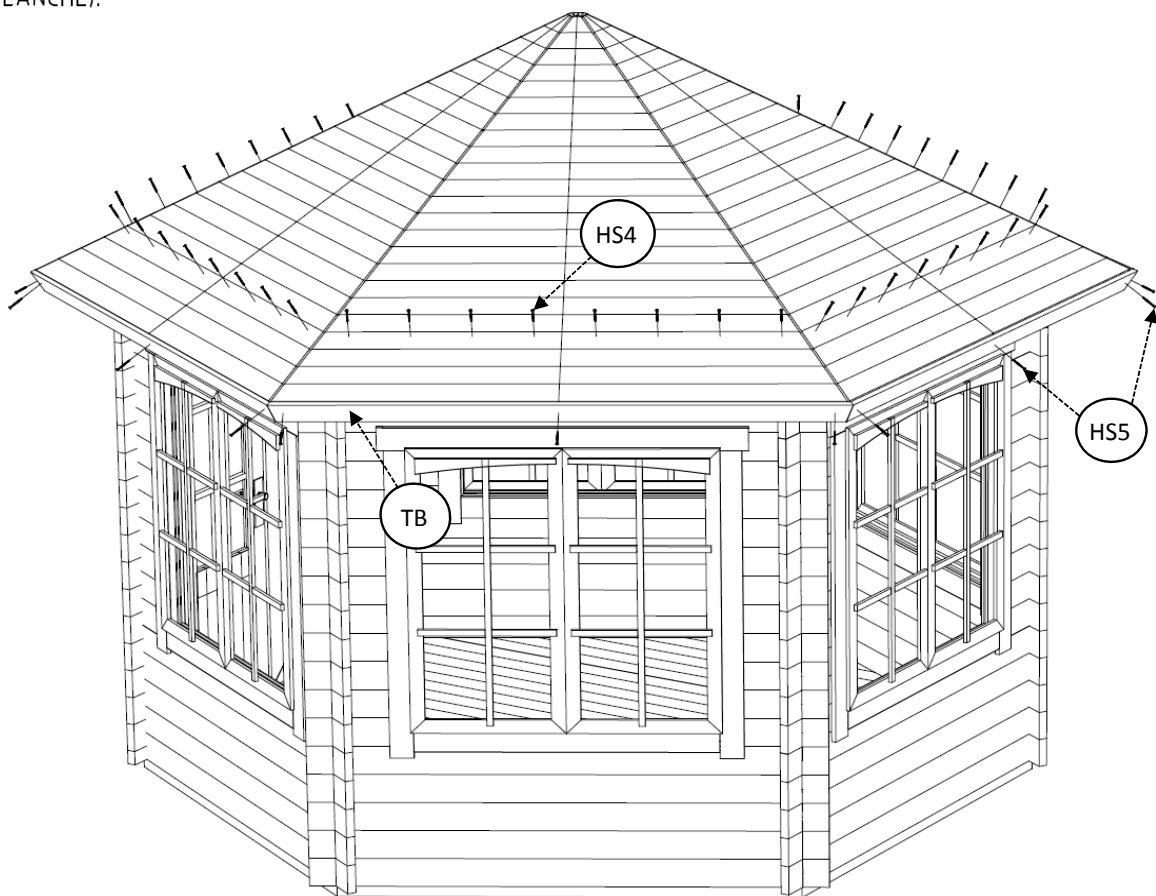





VISSER LES PANNEAUX DE TOIT EN PLACE AUX MADRIERS SUPÉRIEURS DE FINITION (RV1) EN UTILISANT LES VIS HS4 (8 VIS PAR PANNEAUX PRÉASSEMBLÉS). UNE FOIS TERMINÉE, VOUS POUVEZ ENLEVER LES SUPPORTS ML DE CHAQUE PANNEAU ET LE POTEAU DE MAINTIEN DE TOIT AB.





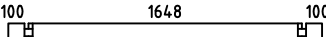
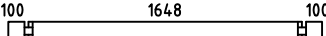
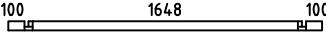
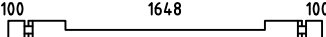
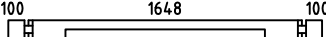
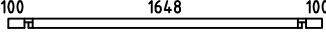
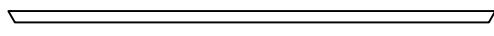
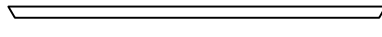
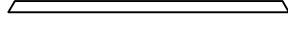
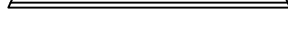
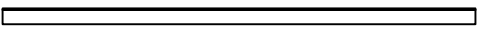
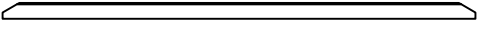
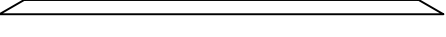
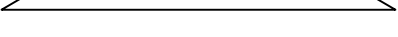

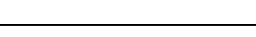
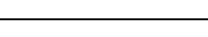
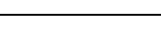
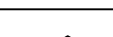



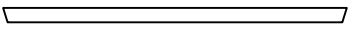

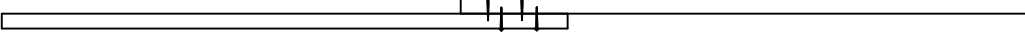
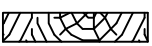

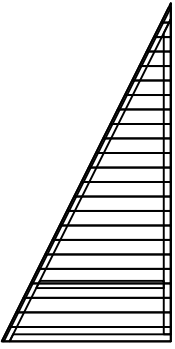
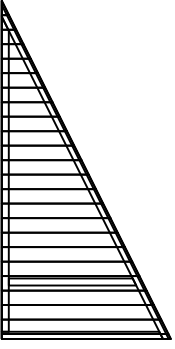
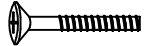
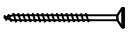
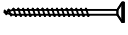

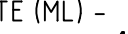

THEN YOU ARE READY TO APPLY SHINGLES OR FELT (NOT SUPPLIED).

NUN KÖNNEN SIE DAMIT BEGINNEN DIE DACHEINDECKUNG ZU VERLEGEN (NICHT IM LIFERUMFANG ENTHALTEN).

VOUS POUVEZ MAINTENANT PROCÉDER À LA MISE EN PLACE DE LA FINITION DE TOITURE (FOURNIE SÉPAREMENT EN OPTION).

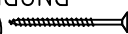
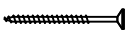
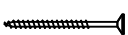
Pos	27.10.2014	Piecelist - Stücklist - Liste des composants Art.Nr. 442300	12/15	Q.	P. (mm)	L. (mm)
001				1	44x57	355
002				1	44x57	355
003				69	44x114	355
004				69	44x114	355
005				32	44x114	1950
006				3	44x114	1950
007				2	44x57	1950
008				2	44x114	1950
009				2	44x114	1950
010				3	44x57	1950
IAR3	FOUNDATION - FUNDAMENT - FONDATION					
				2	70x45	3026
IAR2	FOUNDATION - FUNDAMENT - FONDATION					
				2	70x45	2345
IAR1	FOUNDATION - FUNDAMENT - FONDATION					
				6	70x45	1744
RV1	WALL FINISHING BOARD - ABSCHLUSSBOHLE - MADRIER SUPÉRIEUR DE FINITION					
				6	44x57	1750
	FLOOR BOARDS - FUSSBODENBRETTER - - LAME DE PLANCHER			18	90x18	2939
	FLOOR BOARDS - FUSSBODENBRETTER - - LAME DE PLANCHER			2	90x18	2939
	FLOOR BOARDS - FUSSBODENBRETTER - - LAME DE PLANCHER			2	90x18	2760
	FLOOR BOARDS - FUSSBODENBRETTER - - LAME DE PLANCHER			2	90x18	2449
	FLOOR BOARDS - FUSSBODENBRETTER - - LAME DE PLANCHER			2	90x18	2137
	FLOOR BOARDS - FUSSBODENBRETTER - - LAME DE PLANCHER			2	90x18	1825
	FLOOR BOARDS - FUSSBODENBRETTER - - LAME DE PLANCHER			2	90x18	1513
	FLOOR BOARDS - FUSSBODENBRETTER - - LAME DE PLANCHER			2	90x18	1202
	FLOOR BOARDS - FUSSBODENBRETTER - - LAME DE PLANCHER			2	90x18	890
	FLOOR BOARDS - FUSSBODENBRETTER - - LAME DE PLANCHER			2	90x18	578
	FLOOR BOARDS - FUSSBODENBRETTER - - LAME DE PLANCHER			2	90x18	266

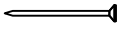
Pos	27.10.2014	Piecelist - Stücklist - Liste des composants Art.Nr. 442300	13/15	Q.	P. (mm)	L. (mm)
LF	FITTING SLAT - LOSE FEDER - PROFIL DE JONCTION			1	6x15	2939
TB	FASCIA BOARD - TRAUFBRETT - BANDEAU DE TOIT			6	18x90	2130
	FLOOR FILLET-FUSSBODENLEISTE - CORNIERE DE FINITION DU PLANCHER			6	18x18	1700
AB	ASSEMBLY BATTEN - MONTAGELATTE - BAGUETTES DE MAINTIEN, NÉCESSAIRES À LA MISE EN PLACE DES PANNEAUX DE TOIT			2	28x34	1800
ML	ASSEMBLY BATTEN - MONTAGELATTE - BAGUETTES DE MAINTIEN, NÉCESSAIRES À LA MISE EN PLACE DES PANNEAUX DE TOIT			12	18x90	
	HAMMER BLOCK - SCHLAGHOLZ - CALLE DE FRAPPE			1		
1	ROOF ELEMENT (LEFT) - DACHELEMENT (LINKE) - PANNEAU DE TOIT PRÉMONTÉ			6	62x1050	2100
2	ROOF ELEMENT (RIGHT) - DACHELEMENT (RECHTE) - PANNEAU DE TOIT PRÉMONTÉ			6	62x1050	2100
	STORM PROTECTION WIRE CABLES - DRAHTSEILE FÜR STURMSICHERUNG - CABLES MÉTALLIQUE ANTI-TEMPÊTE			3		6250
	BOLT FOR WINDOW HANDLE FITTINGS - BOLZEN FÜR FENSTERGRIFF BESCHLAG - BOULON POUR POIGNÉE D'OUVERTURE DE FENETRE			8		
	SCREW FOR DOOR FILLET - SCHRAUBE ZUR BEFESTIGUNG TÜRLEISTE - VIS D'ASSEMBLAGE DU CADRE DE PORTE			5	3x30	
	SCREW FOR WINDOW FILLET - SCHRAUBE FÜR GLASLEISTE - VIS DE FILET DE FENETRE			6	3x30	
	SCREW FOR 1. WALL BEAM - SCHRAUBE FÜR 1. BOHLENREIHE - VIS DE FIXATION DES FONDATIONS			8	5x90	
	SCREW FOR GEORGIAN BARS - SCHRAUBE FÜR SPROSSEN - VIS DE BARRES GEORGIANNE			114	2.5x20	
HS1	SCREW FOR FIXING ROOF ELEMENTS - SCHRAUBE FÜR BEFESTIGUNG DACHELEMENTEN - VIS DE FIXATION DES PANNEAUX DE TOIT			144	4.5x80	
HS2	SCREW FOR ASSEMBLY BATTEN (ML) - SCHRAUBEN FÜR MONTAGELATTE (ML) - - VIS DE FIXATION DES BAGUETTES DE MAINTIEN POUR MISE EN PLACE DU TOIT (ML)			24	4x40	

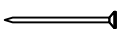
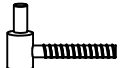
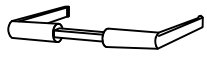
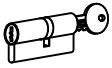
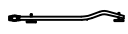
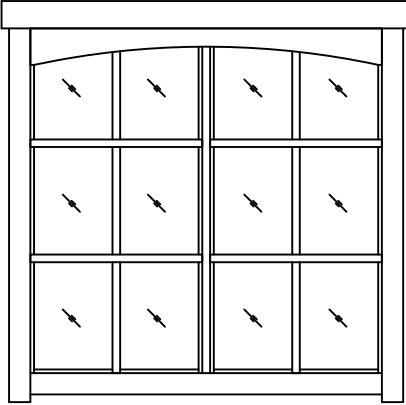
Pos	27.10.2014	Piecelist - Stücklist - Liste des composants Art.Nr. 442300	14/15	Q.	P. (mm)	L. (mm)
HS5		SCREW FOR FASCIA BOARDS - SCHRAUBEN FÜR TRAUFBRETTER - VIS DE FIXATION POUR BANDEAU DE TOIT 		18	4x40	
HS3		SCREW FOR ASSEMBLY BATTEN - SCHRAUBEN FÜR MONTAGELATTE - VIS DE FIXATION DES BAGUETTES DE MAINTIEN POUR MISE EN PLACE DU TOIT 		4	4x60	
		SCREW FOR FUNDAMENT - SCHRAUBEN ZUR BEFESTIGUNG FUNDAMENT - VIS POUR FONDATION 		14	5x90	
HS4		SCREW FOR FIXING ROOF ELEMENTS WITH RV1 - SCHRAUBE FÜR BEFESTIGUNG DACHELEMENTEN (RV1) - VIS DE FIXATION DES PANNEAUX DE TOIT (RV1) 		48	5x90	
		SCREW FOR WALL FINISHING BOARD RV1 - SCHRAUBE FÜR ABSCHLUSSBOHLE RV1 - VIS D'ASSEMBLAGE DES MADRIERS SUPÉRIEUR DE FINITION RV1 		18	5x90	
		SCREW FOR DOOR JAMB - SCHRAUBE FÜR TÜRRAHMEN - VIS DE FIXATION POUR MONTANT DE PORTE 		4	5x90	
		WINDOW HANDLE FITTINGS - FENSTERGRIFF - POIGNÉE D'OUVERTURE DE FENETRE 		4		
		ZN NAIL FOR FLOOR FILLET - ZN NÄGEL FÜR FUSSBODENLEISTE - POINTE POUR CORNIERE DE FINITION DU PLANCHER 		24	1.4x40	
		SET OF DOOR LOCK COVERS - SCHLOSSBLENDEN - SET DE GARNITURES DE SERRURE DE PORTE 		1		
		SCREW FOR DOORSTEP - SCHRAUBEN FÜR SWELLE - VIS DE FIXATION DU SEUIL DE PORTE 		3	4.5x65	
		ZN NAIL FOR FLOOR - ZN NÄGEL FÜR FUSSBODENBRETTER - CLOUS POUR PLANCHER 		214	2x50	
		MALE BOLT HINGE FOR DOOR - TÜRRIEGEL - PARTIE MALE DE CHARNIERE DE PORTE 		6		
		SCREW-EYELETS FOR STORM PROTECTION - SCHRAUBÖSEN FÜR STURMSICHERUNG - OEILLETS DE VISSAGE POUR LAME ANTI-TEMPÊTE		6		
		CLAMPS FOR STORM PROTECTION - KLEMMEN FÜR STURMSICHERUNG - COLLIER POUR LAME ANTI-TEMPÊTE		12		
		TURNBUCKLES FOR STORM PROTECTION - SPANNSCHLÖSSER FÜR STURMSICHERUNG - TENDEUR À VIS POUR LAME ANTI-TEMPÊTE		3		
		DOOR HANDLE FITTINGS - TÜRGRIFF - SET DE GARNITURES DE SERRURE DE PORTE 		1		
		CYLINDER LOCK - ZYLINDERSCHLOSS - CYLINDRE DE SERRURE 		1		
		WINDOW FIXATOR - FENSTERFIXIERUNG - FENÊTRE FIXATOR 		2		
		WINDOW - FENSTER - FENETRE 1232x1210 TAK.1.106.SM0.Kd SGC+A		3		
						

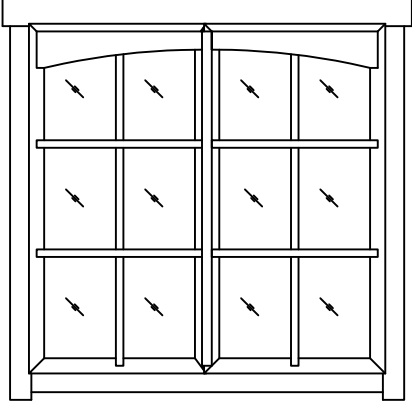
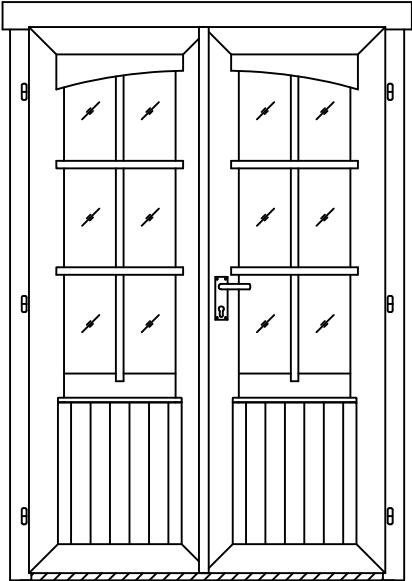
Pos	27.10.2014 Piecelist - Stücklist - Liste des composants Art.Nr. 442300	15/15	Q.	P. (mm)	L. (mm)
	<p data-bbox="183 136 703 165">WINDOW - FENSTER - FENETRE 1232x1210</p> <p data-bbox="906 136 1222 165">TAK.1.106.SVP.Kd SGC+A</p> 	2			
	<p data-bbox="183 725 587 754">DOOR - TÜR - PORTE 1232x1850</p> <p data-bbox="839 725 1222 754">TUK.2.066.SVP.MMWKc SGC+A</p> 	1			