

Art. Nr. 402196
1/7

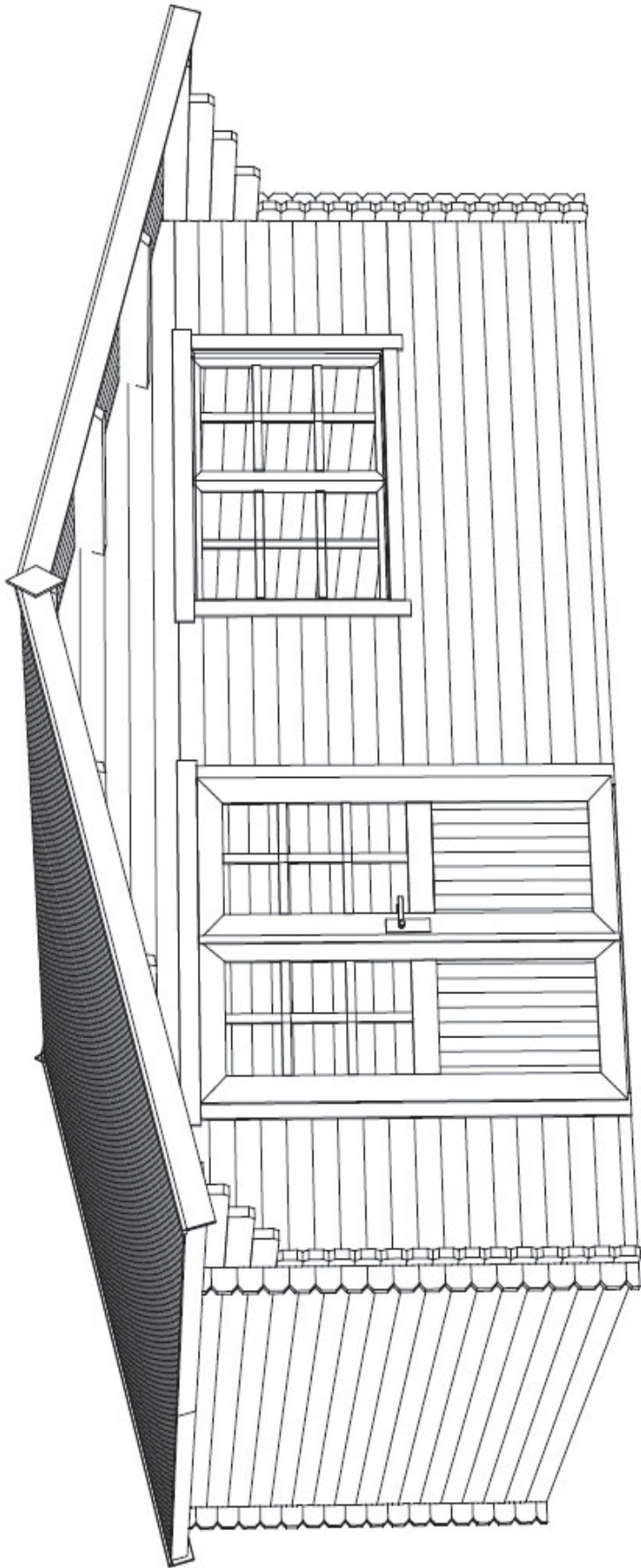

30.10.2017

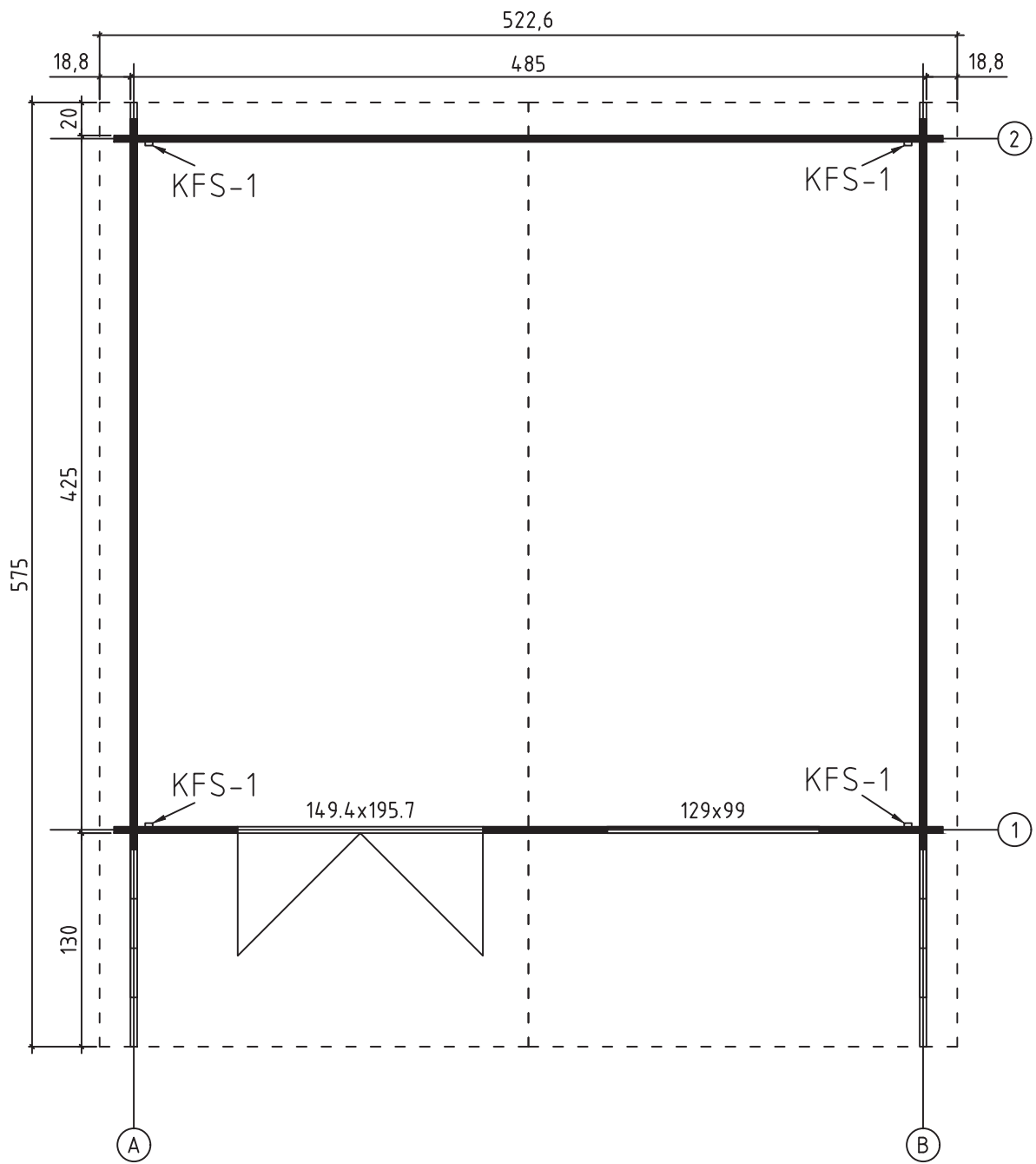





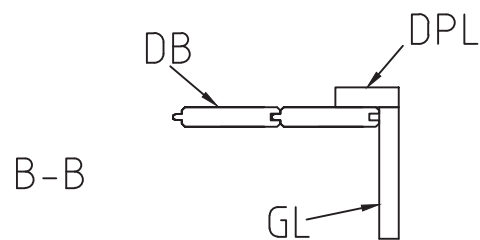
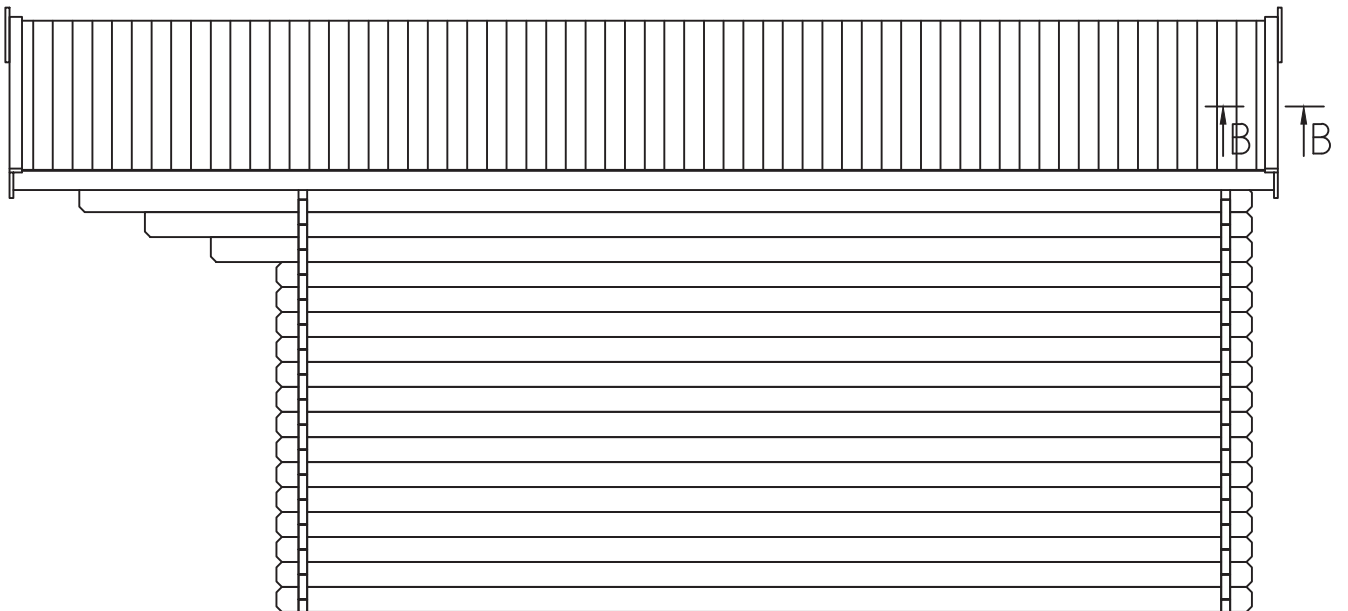
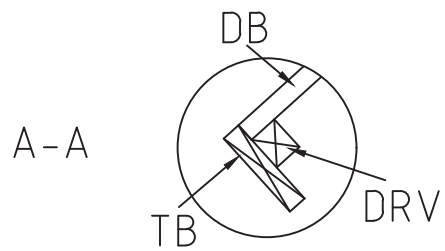
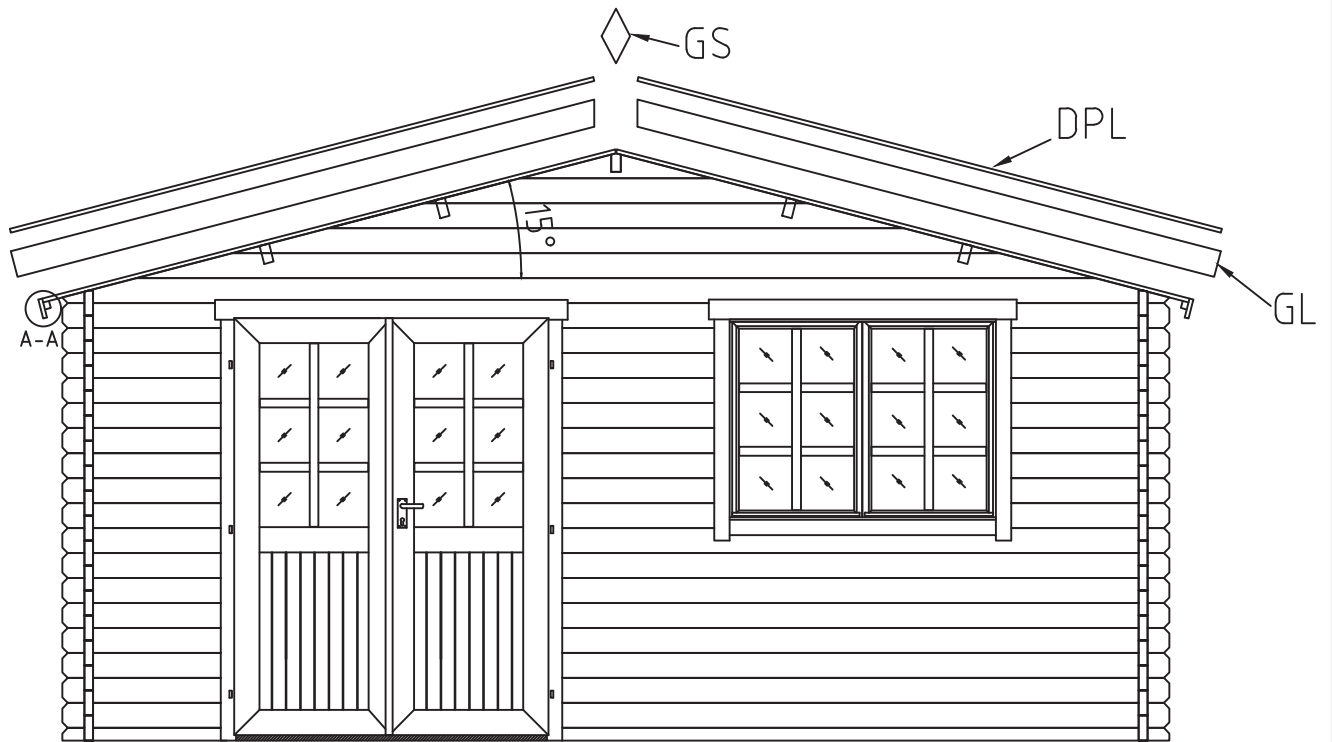



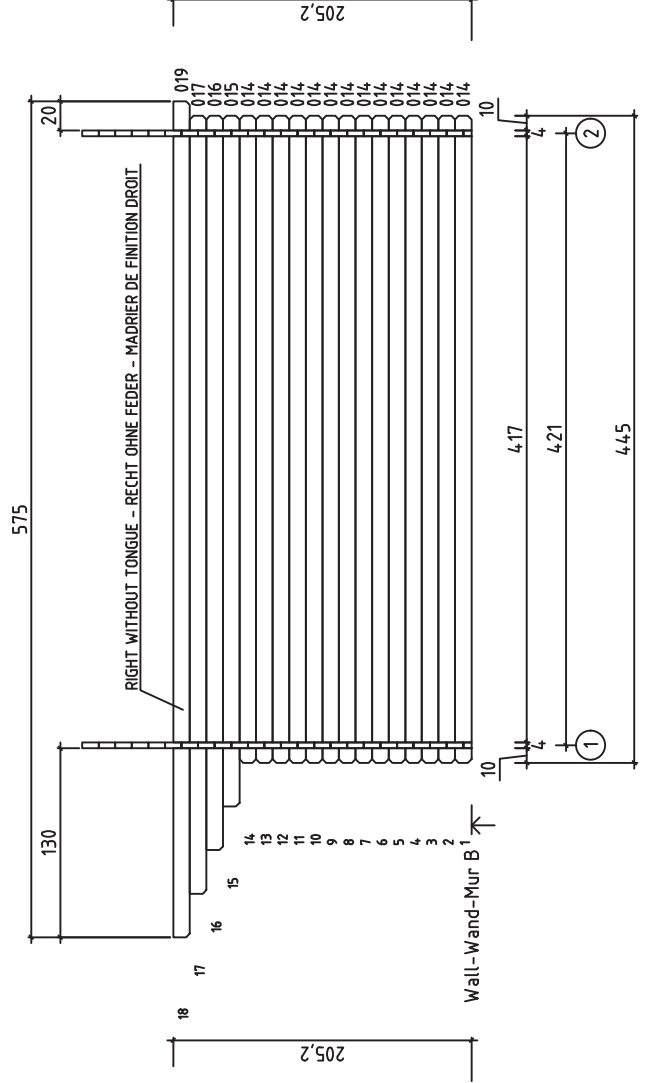
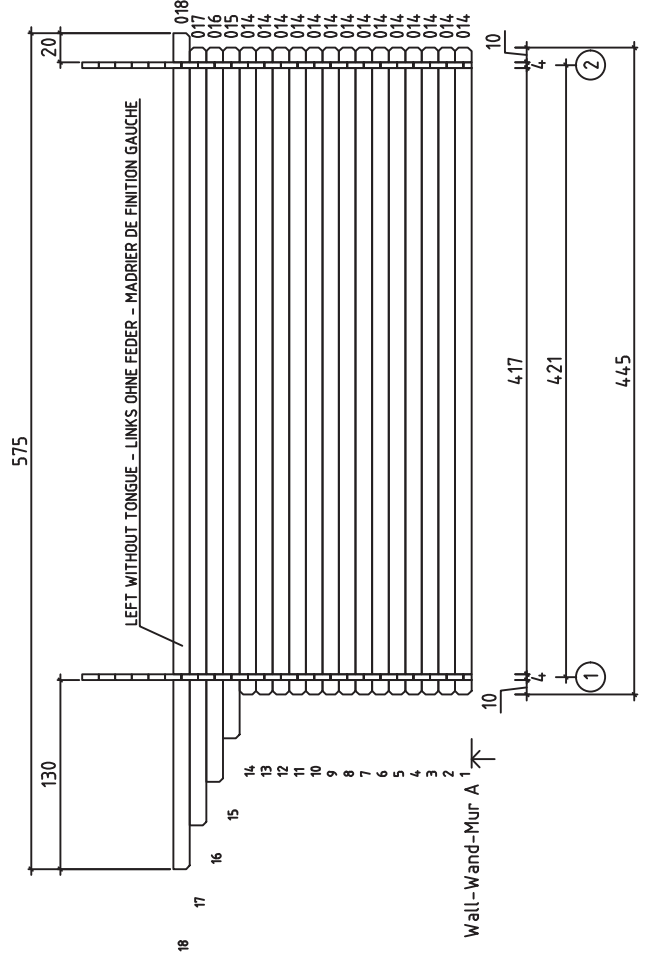
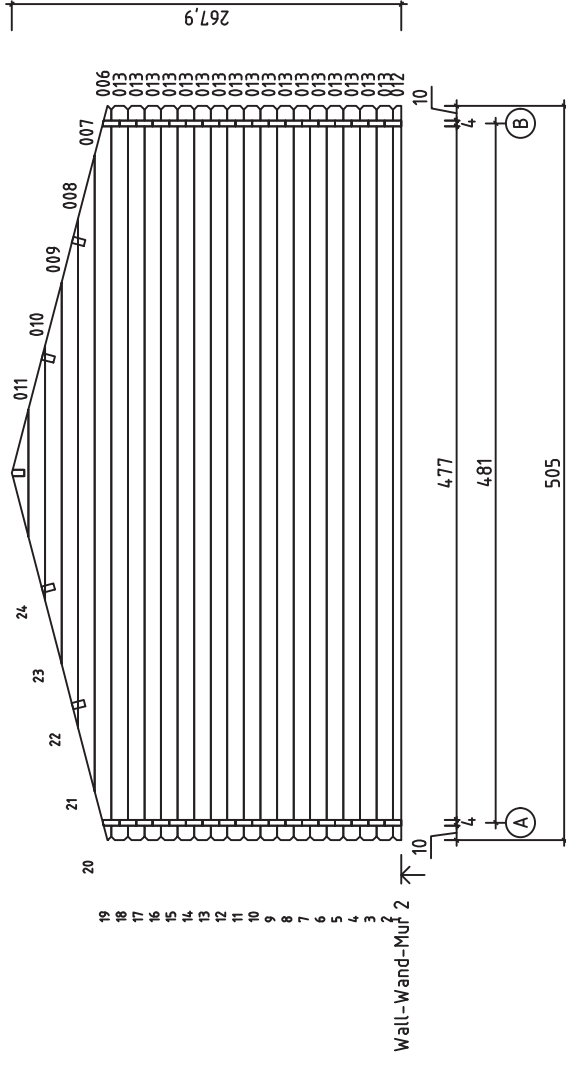
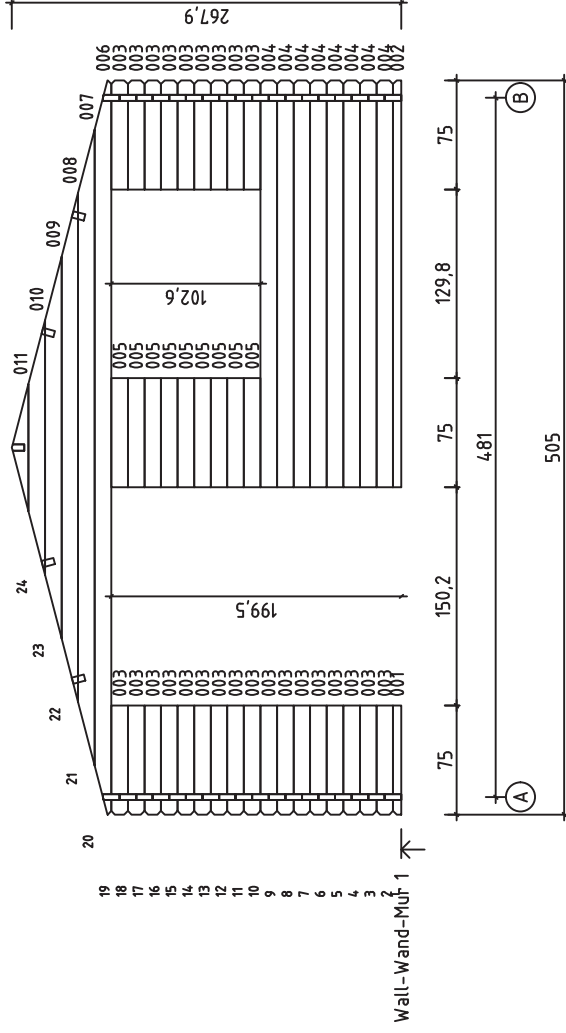

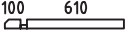
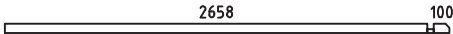
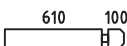
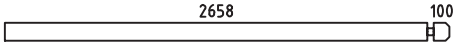
GROUNDPLAN - GRUNDPLAN - PLAN DE MASSE

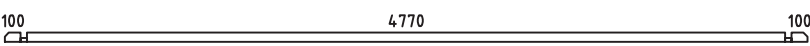
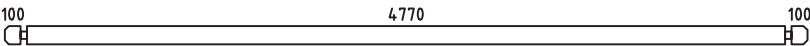
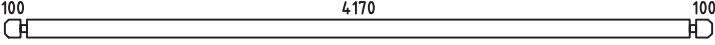
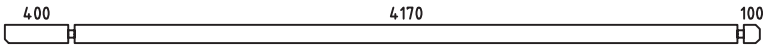
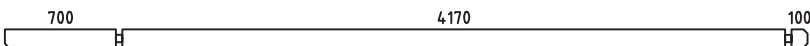
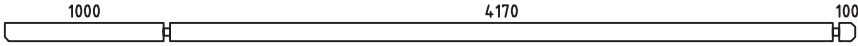

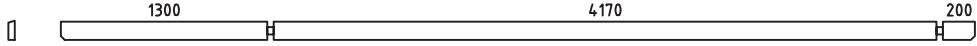
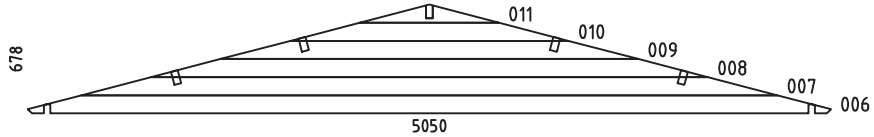
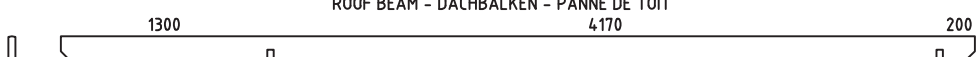
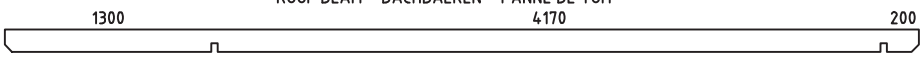

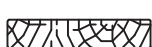

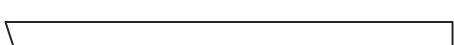





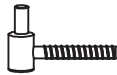

Art.Nr. 402196

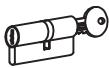

Art.Nr. 402196

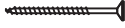

Pos	30.10.2017	Piecelist - Stücklist - Liste des composants Art.Nr. 402196	5/7	Q.	P. (mm)	L. (mm)
001				1	40x57	750
002				1	40x57	2798
003				26	40x114	750
004				8	40x114	2798
005				9	40x114	750
012				1	40x57	5050
013				17	40x114	5050
014				28	40x114	4450
015				2	40x114	4750
016				2	40x114	5050
017				2	40x114	5350
018				1	40x120	5750
019				1	40x120	5750
W1-1 W2-1				2		
PR1		ROOF BEAM - DACHBALKEN - PANNE DE TOIT		1	44x140	5750
APR1		ROOF BEAM - DACHBALKEN - PANNE DE TOIT		4	44x140	5750
DB	ROOF BOARDS - DACHBRETTER - VOLIGES			128	90x18	2700
DPL	ROOFING FELT FILLET - DACHPAPPENLEISTE - - BAGUETTE DE FIXATION DU FEUTRE BITUMEUX			4	18x58	2750
TB	EAVES BOARD - TRAUFBRETT - BANDEAU DE TOIT			4	18x90	2750
DRV	ROOF EDGE REINFORCEMENT - DACHRANDVERSTÄRKUNG - - CORNIERE DE RENFORT DE BORD DE TOIT			4	28x34	2875
KFS-1	STORM PROTECTION - STURMLEISTE - - LATTE ANTI-TEMPETE			4	22x45	2050
GL	GABLE MOULDING - GIBELLEISTE - - PLANCHE DE RIVE			4	18x120	2750
GS	GABLE SEGMENT-DECKBLATT - LOSANGE DE FINITION			2		
SH40	HAMMER BLOCK - SCHLAGHOLZ - CALLE DE FRAPPE 40mm			1		300

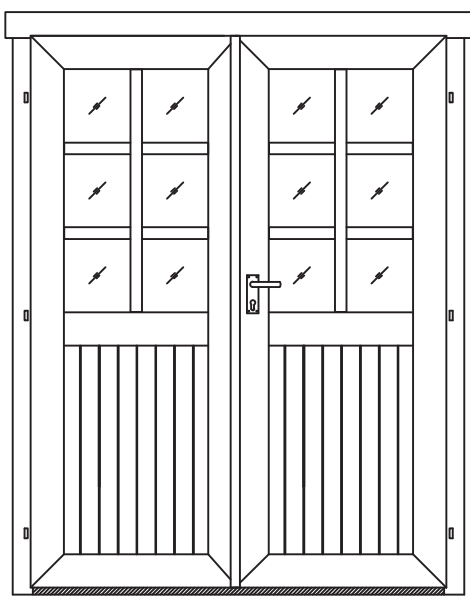
Pos	30.10.2017	Piecelist - Stücklist - Liste des composants Art.Nr. 402196	6/7	Q.	P. (mm)	L. (mm)
SFS		NUT FOR STORM PROTECTION - SCHRAUBENMUTTER FÜR STURMLEISTE - ÉCROU POUR LAME ANTI-TEMPETE		8	D6	
BFS		BOLT FOR STORM PROTECTION - BOLZEN FÜR STURMLEISTE - - VIS POUR LAME ANTI-TEMPETE		8	6x70	
DFS		WASHER FOR STORM PROTECTION - DICHTSCHEIBE FÜR STURMLEISTE - - RONDELLE POUR LAME ANTI-TEMPETE		8	D6	
HS41		SCREW FOR DOOR JAMB - SCHRAUBE FÜR TÜRRAHMEN - - VIS DE FIXATION POUR MONTANT DE PORTE		4	5x90	
HS59		SCREW FOR DOORSTEP - SCHRAUBEN FÜR SWELLE - - VIS DE FIXATION DU SEUIL DE PORTE		3	4.5x65	
		MALE BOLT HINGE FOR DOOR - TÜRRIEGEL - - PARTIE MALE DE CHARNIERE DE PORTE		6	16/52	
TL5		SET OF DOOR LOCK COVERS - SCHLOSSBLENDEN - - SET DE GARNITURES DE SERRURE DE PORTE		1		
TL4		DOOR HANDLE FITTINGS-TÜRGRIF - - GARNITURE DE POIGNÉE DE PORTE		1		
		CYLINDER -ZYLINDERSCHLOSS - CYLINDRE DE SERRURE		1	30/35	
HS3		SCREW FOR FILLET - SCHRAUBE ZUR BEFESTIGUNG TÜRLEISTE - - VIS D'ASSEMBLAGE DU CADRE DE PORTE		5	3x30	
FS		WINDOW HANDLE FITTINGS-FENSTERGRIFF - POIGNÉE D'OUVERTURE DE FENETRE		1		
		BOLT FOR WINDOW HANDLE FITTINGS - BOLZEN FÜR FENSTERGRIFF BESCHLAG - BOULON POUR POIGNÉE D'OUVERTURE DE FENETRE		2		
HS3		SCREW FOR WINDOW FILLET - SCHRAUBE FÜR GLASLEISTE - VIS DE FILET DE FENETRE		3	3x30	
		WINDOW/DOOR CROSS SLOT STRAIGHT (PLASTIC) - FENSTER/TÜREN EISENWAREN - QUINCAILLERIE POUR PORTES ET FENETRES		24		
		NAIL FOR WINDOW/DOOR CROSS SLOT STRAIGHT - NÄGEL FÜR FENSTER/TÜREN EISENWAREN - POINTE POUR QUINCAILLERIE POUR PORTES ET FENETRES		48	1.4x30	
		STRIKER FOR BARREL BOLT - HÜLSE FÜR GRENDLRIEGEL - GACHE AU SOL DU TARGETTE		2		
		DOOR - TÜR - PORTE 1494x1957 SGC+E		1		
		TUK.2.056.SVP.MMPb				
						

+E

