

Name

Lissabon 6 4:10x320+VD 4.0

Zeichnung/Drawing

3D

Profil/Profile

4 x 11,4

Datum/Date

07.01.2020

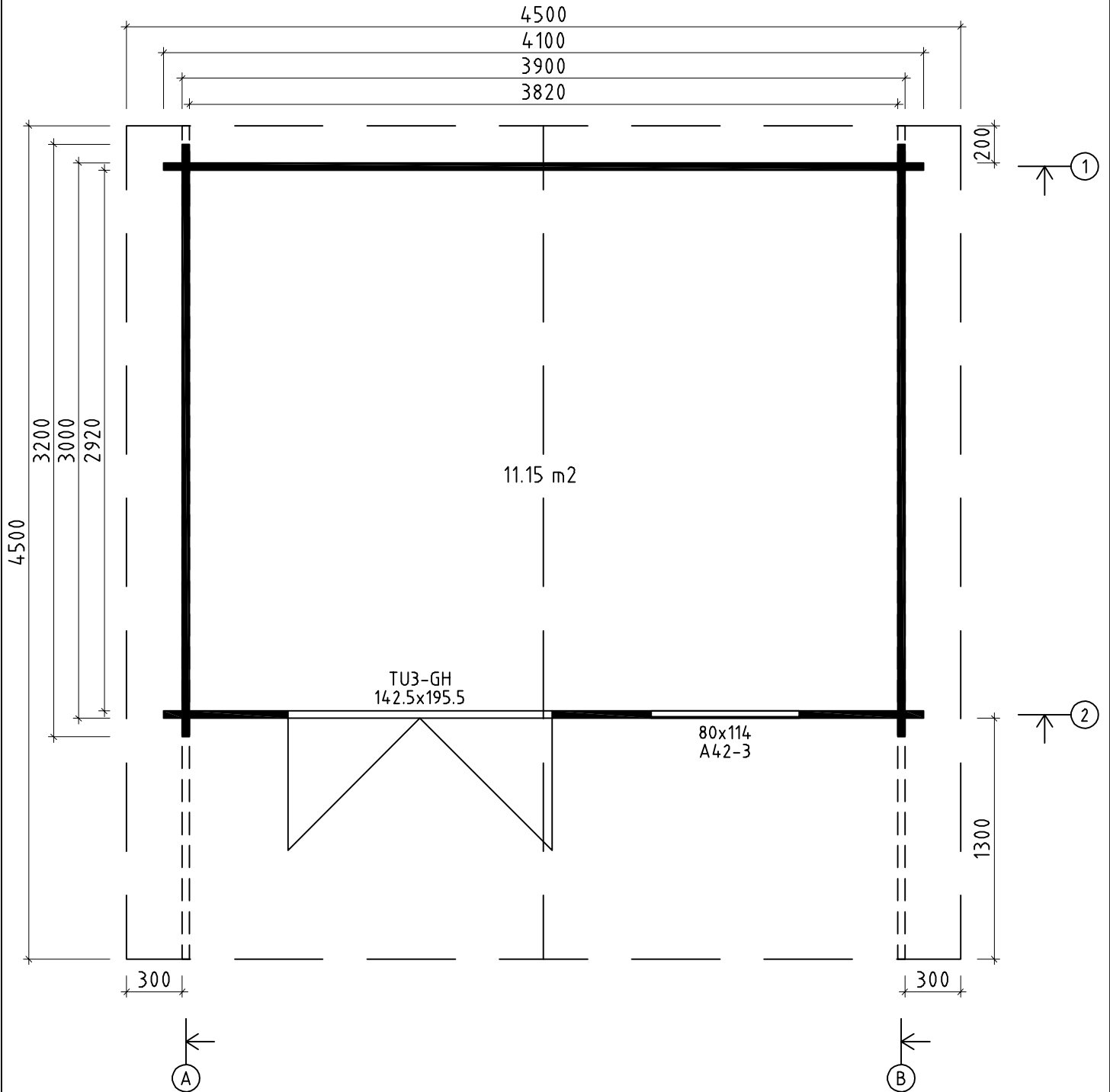



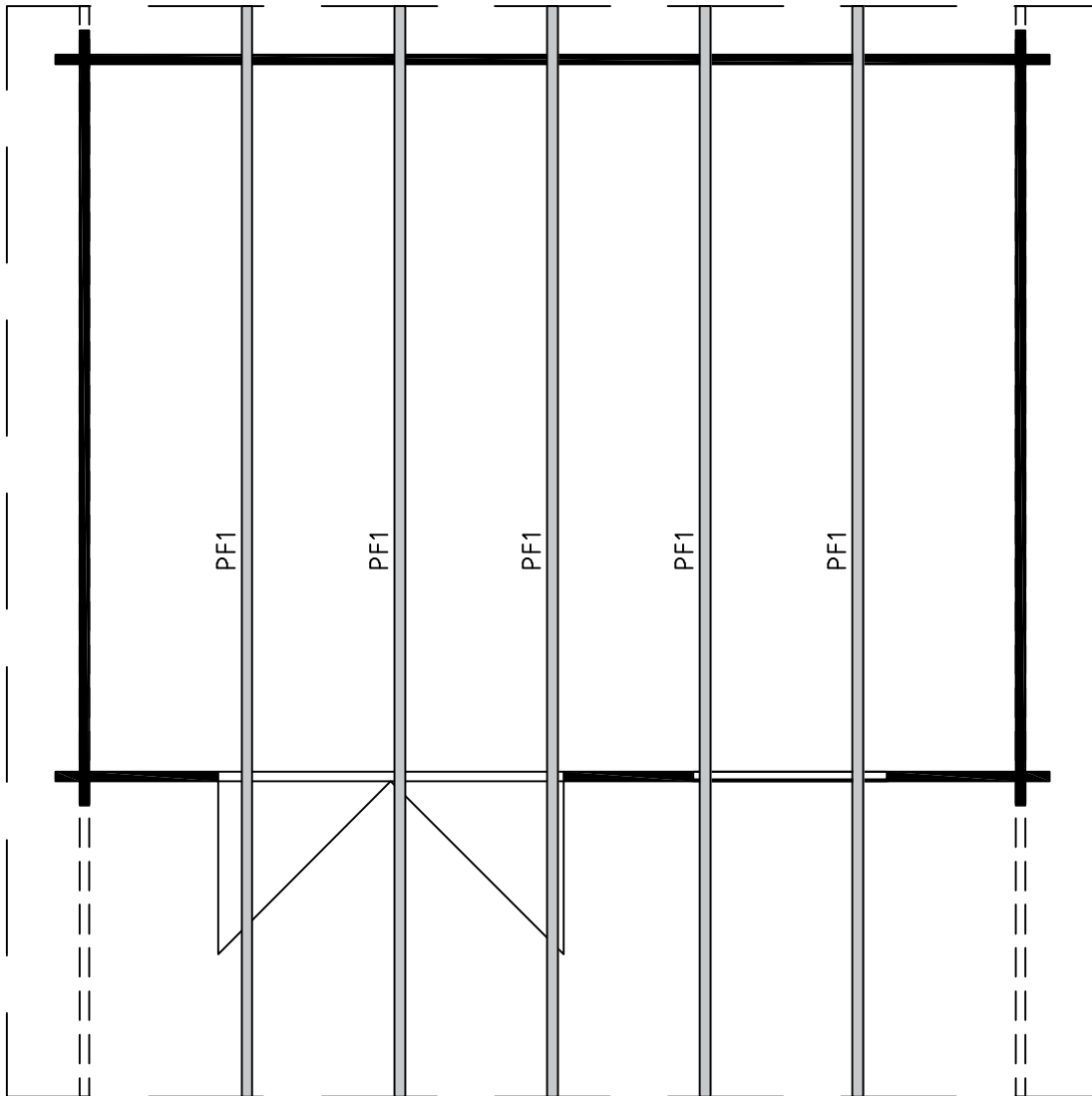

\* Fenster und Türen sind mit Sprossen/  
Windows and doors are with muntins

Name	Lissabon 6 410x320+VD 40		
Zeichnung/Drawing	Grundplan/Plan		
Profil/Profile	4x11.4	Datum/Date	07.01.2020

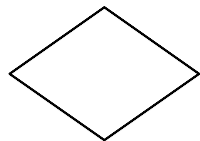
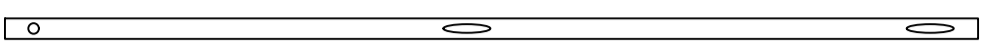
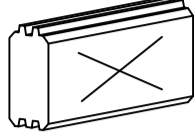
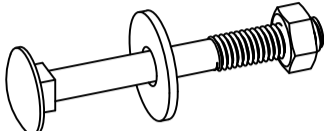

Name	Lissabon 6 410x320+VD 40		
Zeichnung/Drawing	Pfetten/Purlins		
Profil/Profile	4x11.4	Datum/Date	07.01.2020

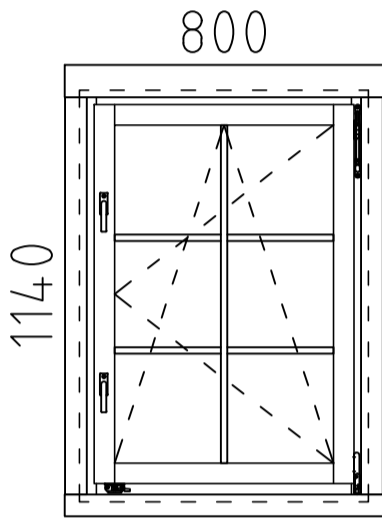
Pos	Teileliste/Specification Lissabon 6 410x320+VD 40		Stck Pcs.	Profil Profile (mm)	Länge Length (mm)	
001			1	40x114	4500	
002			1	40x114	4500	
003			2	40x114	4100	
004			2	40x114	4100	
005			1	40x57	4100	
006			17	40x114	4100	
007			2	40x114	3800	
008			2	40x114	3500	
009			2	40x114	3400	
010			28	40x114	3200	
011			2	40x114	2561	
012			1	40x114	2000	
013			6	40x114	2000	
014			1	40x57	2000	
015			2	40x114	1722	
016			27	40x114	665	
017			1	40x57	665	
018			10	40x114	525	
019			4	40x114	420	
PF1		PFETTEN - PURLINS 2920	5	44x145	4500	
	DACHBRETTER - ROOF BOARDS			80+1	113x18	2332
G02-1	GIEBELBRETTER - GABLE BOARDS 18x120	15,2°		4	18x120	2412
G06-1	GIEBELDECKLEISTEN - GABLE COVER STRIPS 18x58			4	18x58	2412
T01-1	TRAUFENBRETTER - EAVES BOARDS 18x90			2	18x90	4500
T06-1	TRAUFENLEISTEN - EAVES STRIPS 18x40				18x40	9,0 lfm/rm
Kood	Lissabon 6 410x320+VD 40	Materjal	File		Leht 1/2	

Pos	Teileliste/Specification Lissabon 6 410x320+VD 40			Stck Pcs.	Profil Profile (mm)	Länge Length (mm)
GS	GIEBELSEGMENT - GABLE DIAMOND			2		
SM-1	SturMLEISTEN - Storm reinforcement			4	18x40	1995
SH	SCHLAGHÖLZER - MOUNTING PIECES			3		
SS13	Schloßschrauben - Wood bolts M8x70 Mutter - Nut M8 U-Scheibe - Washer Ø25- für SturMLEISTEN - for storm reinforcements			12	M8	
TST	Türstopper - Doorstop			1		
	FENSTER/WINDOW		800x1140 A42-3		1	
			A42-3			
	TÜR/DOOR		1425x1955 TU3-GH		1	
			TU3-GH DIN rechts/right handed			
	 - Bitte selber anpassen (falls nötig)! / Cut into length on site (if needed)!					

Ukse montaaž / Tür montage / Door assembly  
28-40mm (GH)

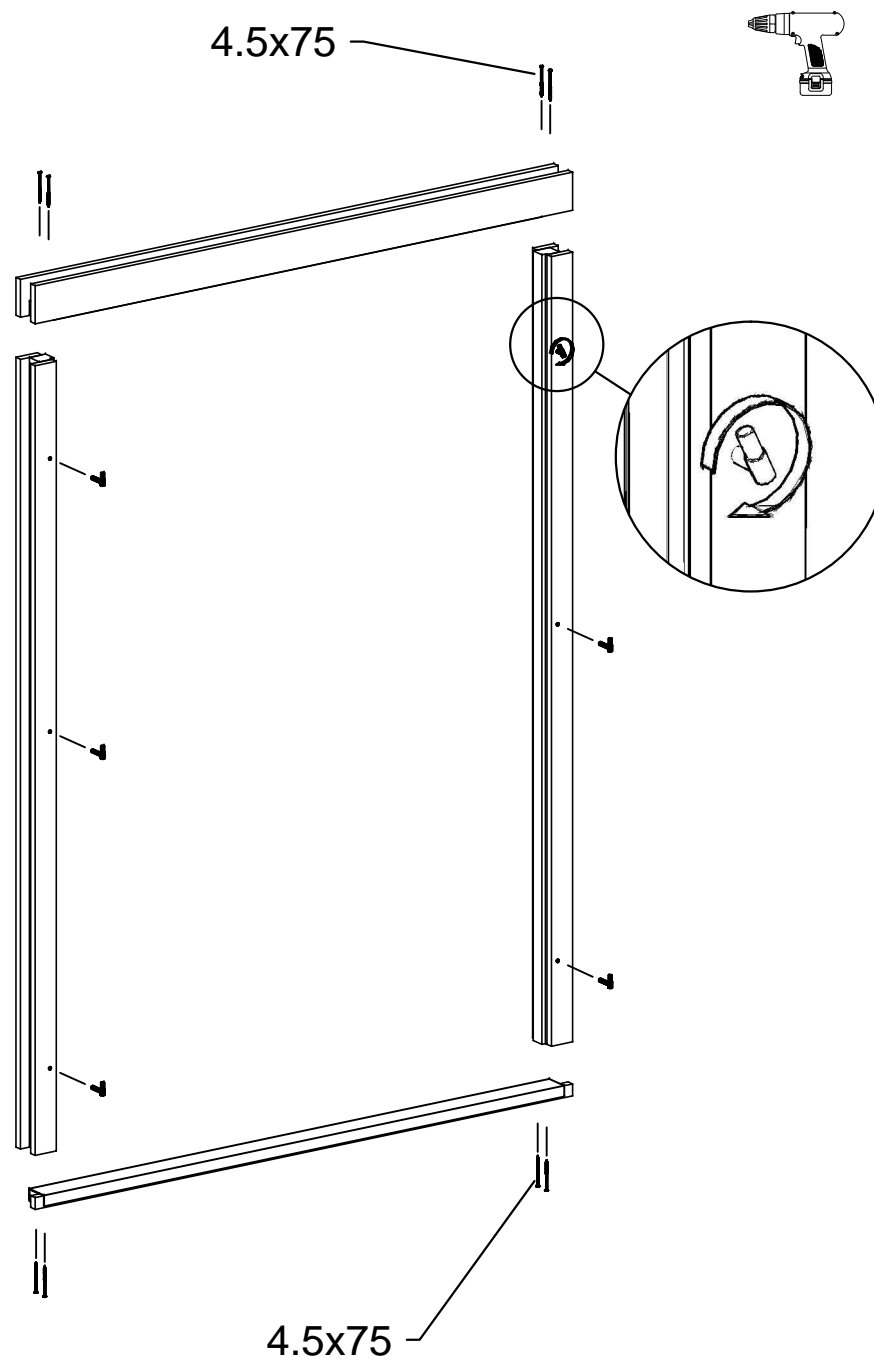
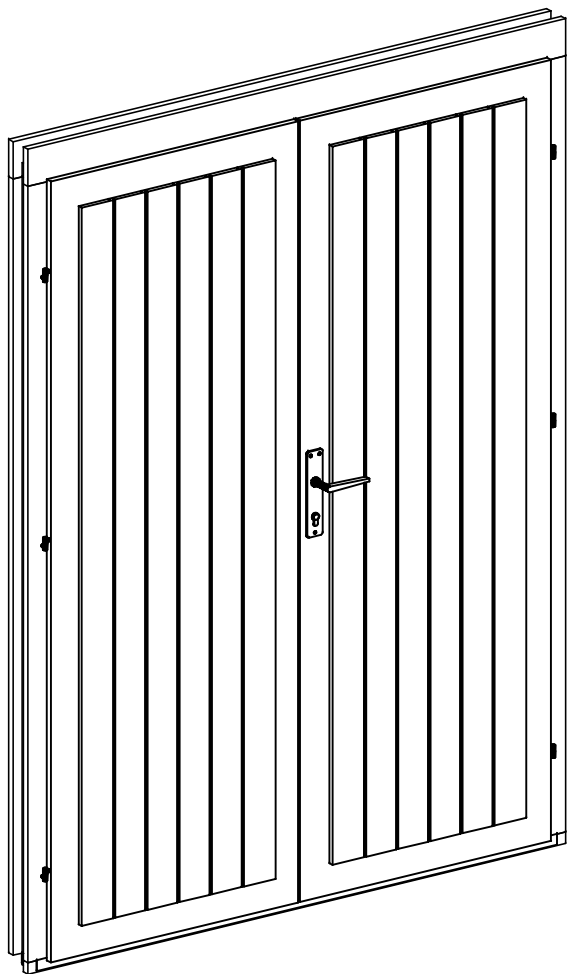

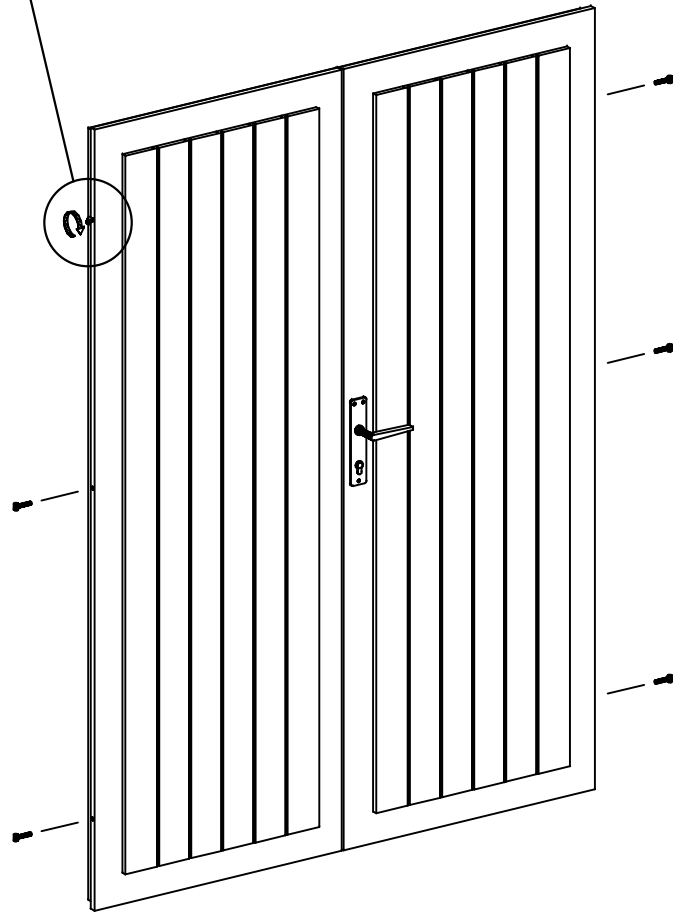
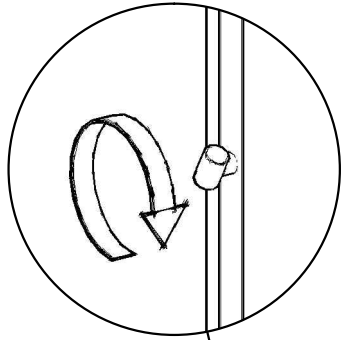

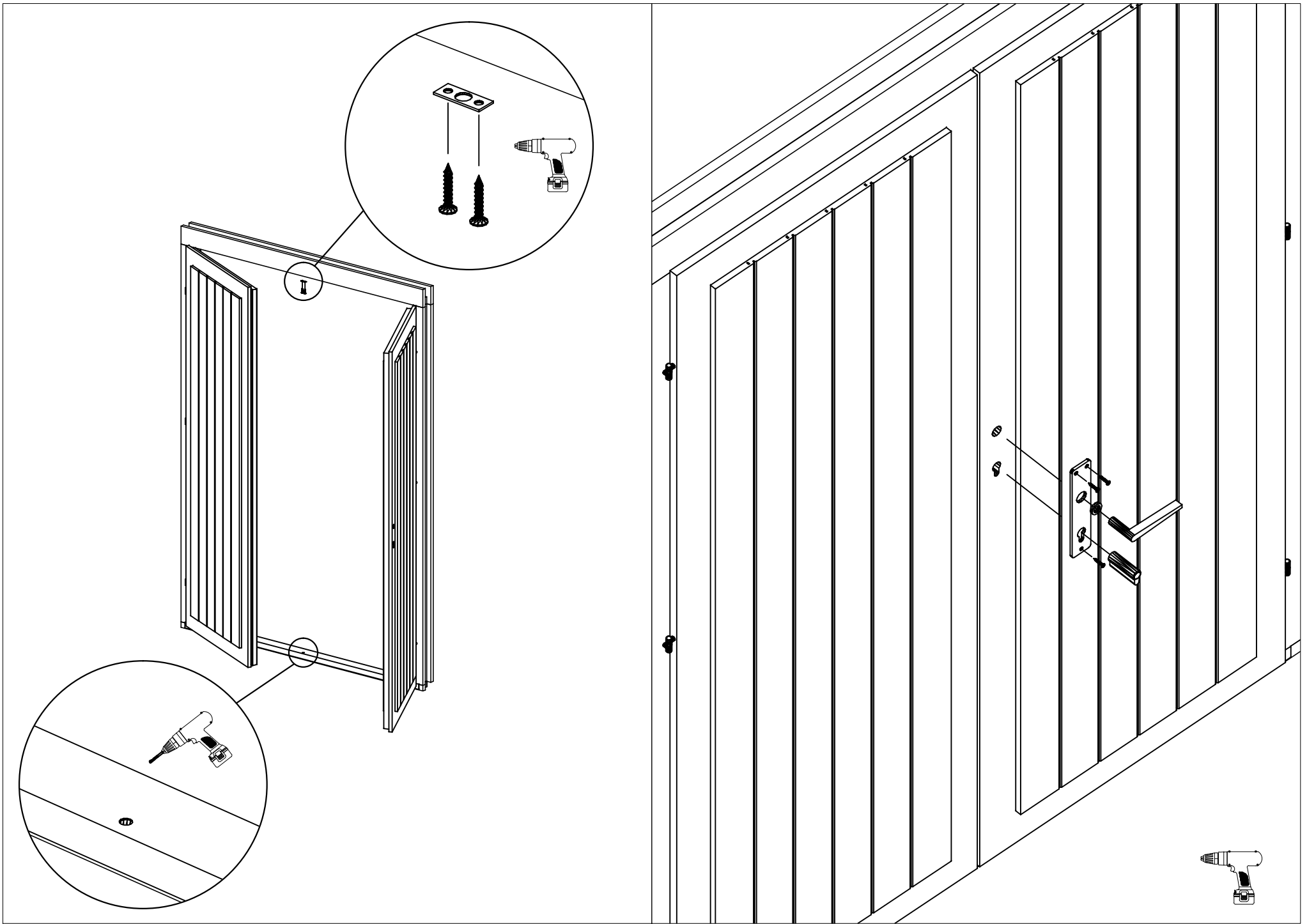



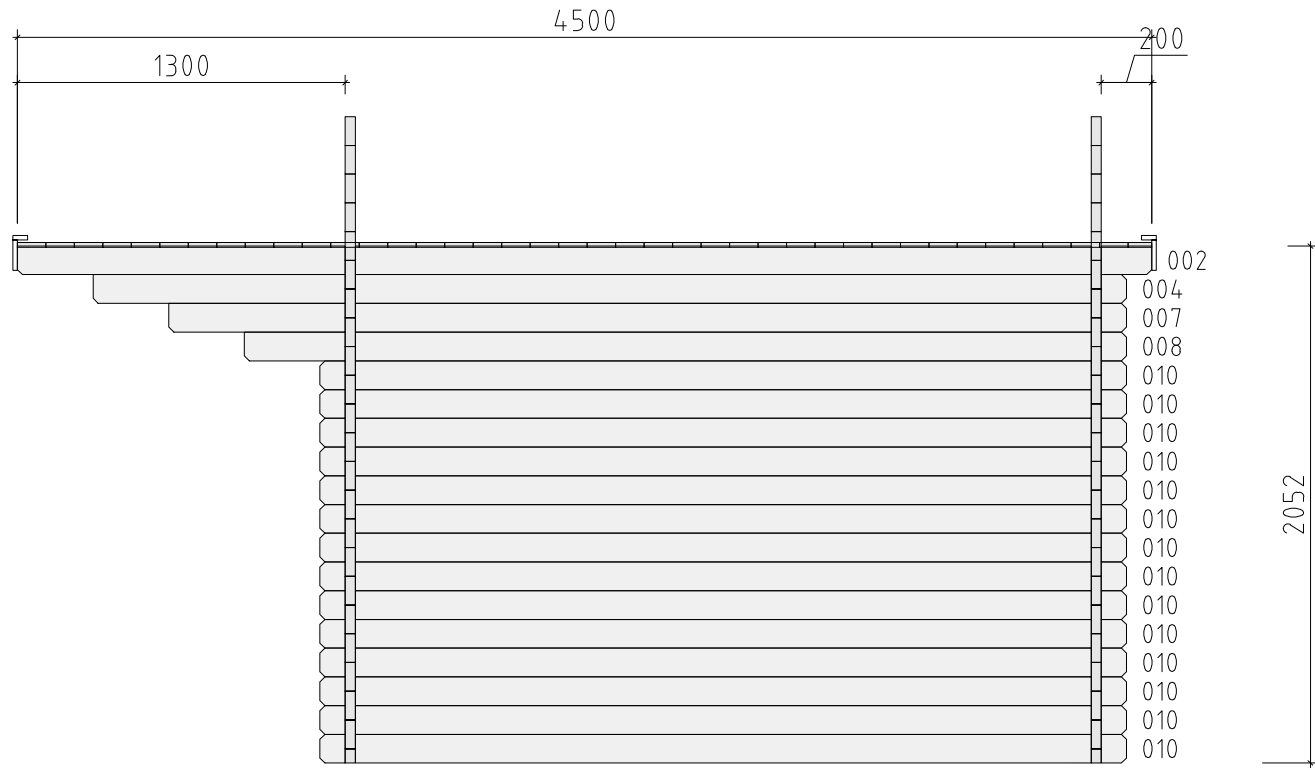
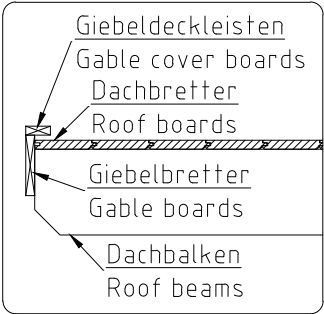

Wand/Wall A ↑

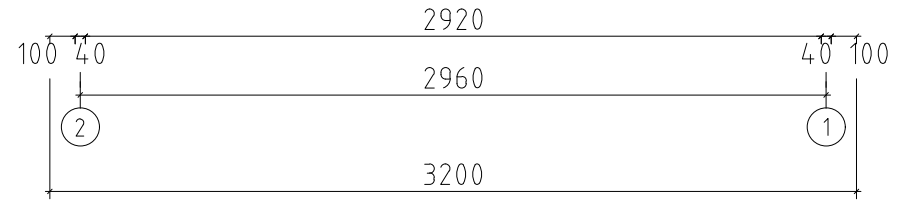

Name	Lissabon 6 410x320+VD 40		
Zeichnung/Drawing	WAND/WALL A		
Profil/Profile	4.0x11.4	Datum/Date	07.01.2020

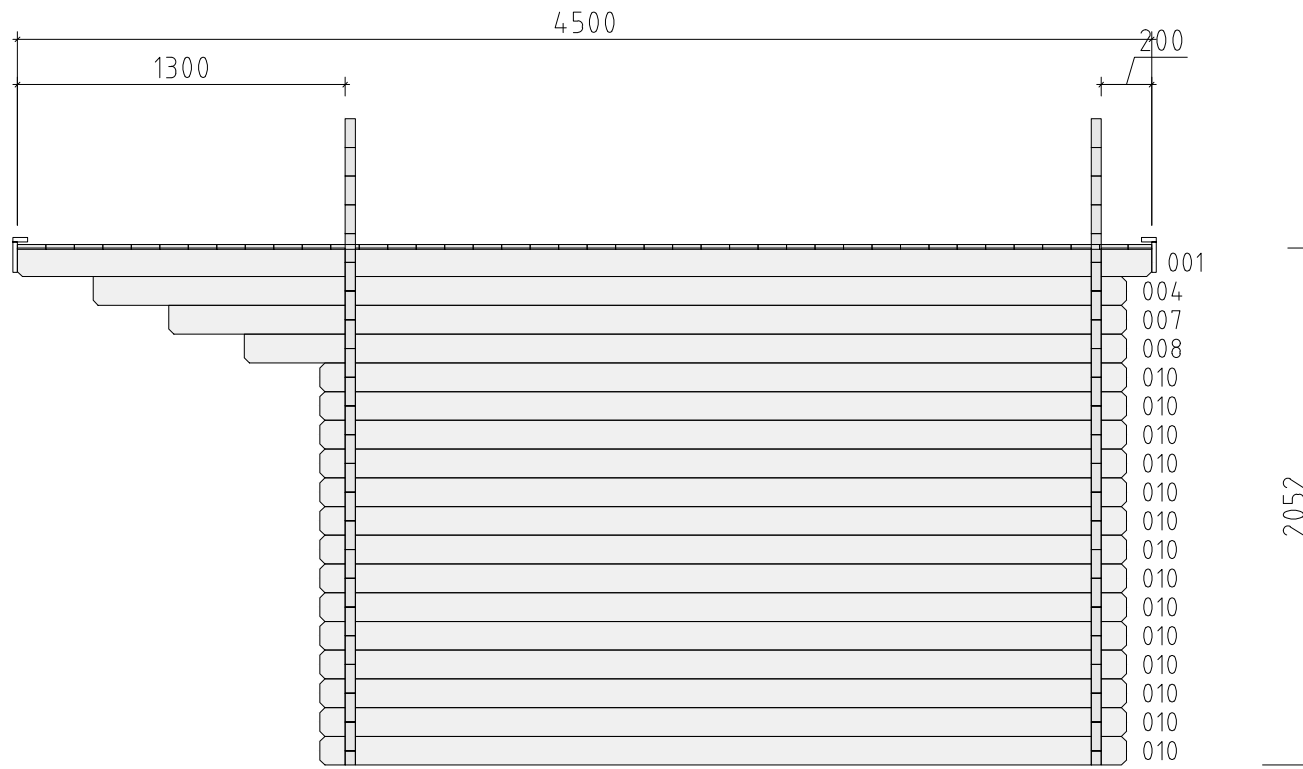

Wand/Wall B ↑

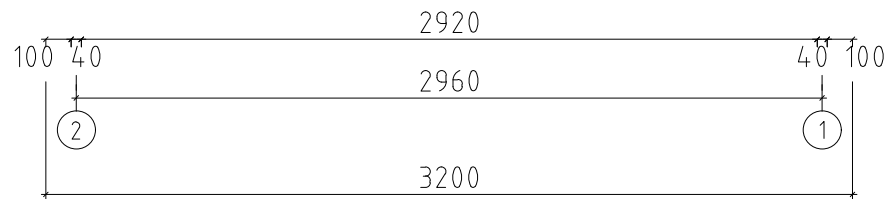

Name	Lissabon 6 410x320+VD 40		
Zeichnung/Drawing	WAND/WALL B		
Profil/Profile	4.0x11.4	Datum/Date	07.01.2020

- Dachbretter
- Roof boards
- Traufenbretter
- Gable boards
- Traufenleisten
- Eaves strips

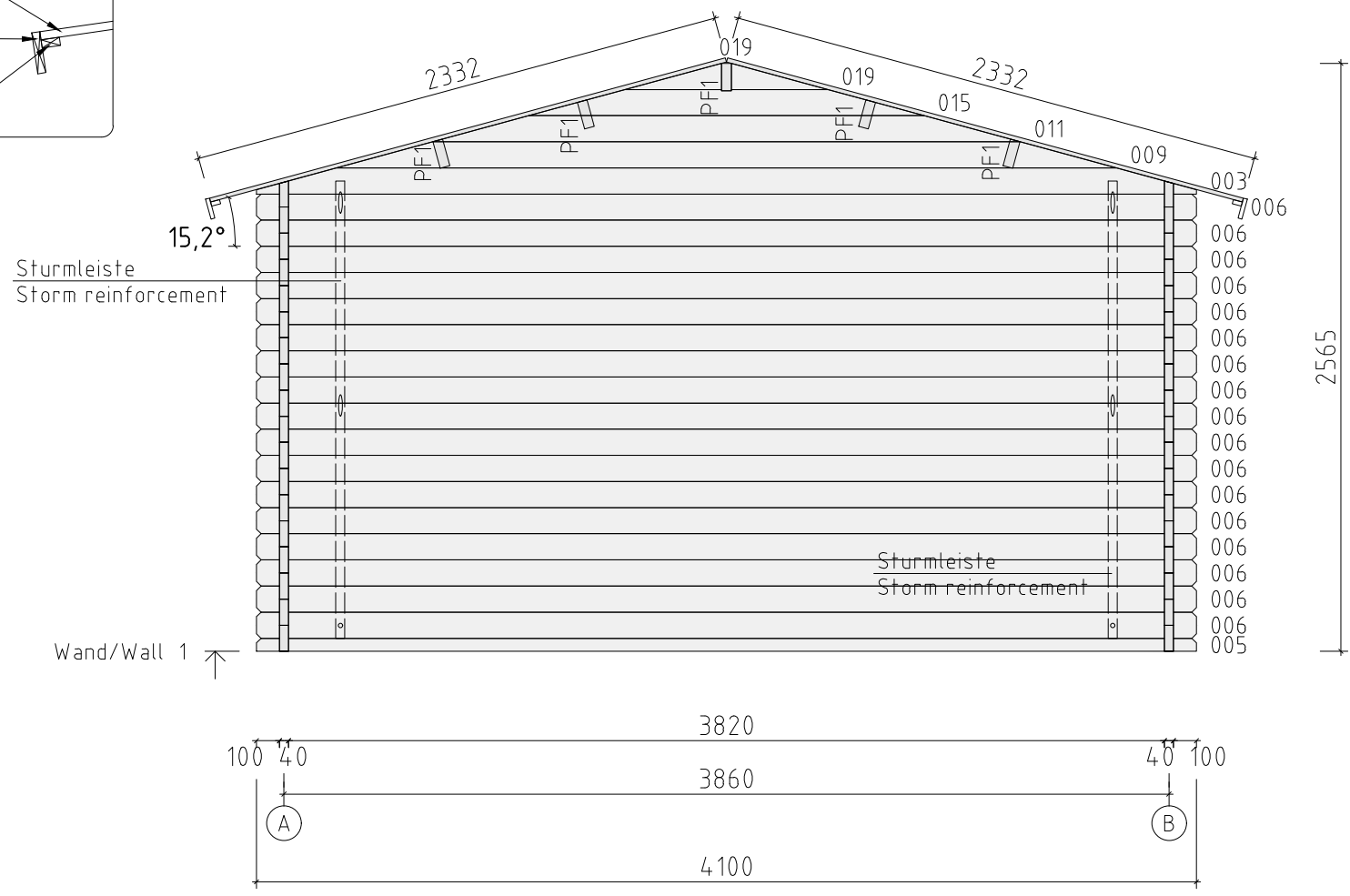

Name	Lissabon 6 410x320+VD 40		
Zeichnung/Drawing	WAND/WALL 1		
Profil/Profile	4.0x11.4	Datum/Date	07.01.2020

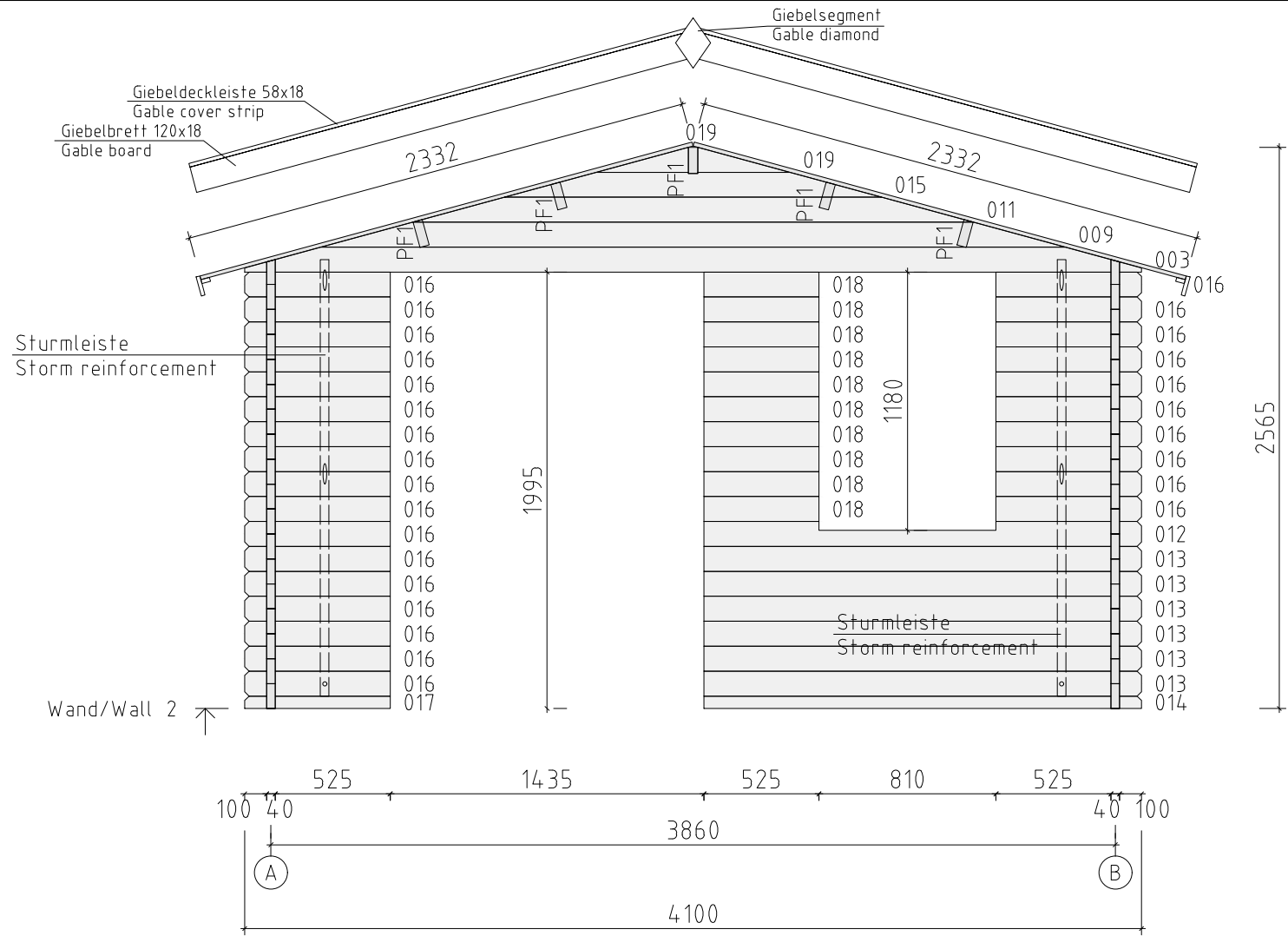

Name	Lissabon 6 410x320+VD 40		
Zeichnung/Drawing	WAND/WALL 2		
Profil/Profile	4.0x11.4	Datum/Date	07.01.2020